

bq2512x 700-nA Low I_Q Highly Integrated Battery Charge Management Solution for Wearables and IoT

1 Features

- Increases System Operation Time Between Charges
 - Configurable 300-mA Buck Regulator (1.8-V Default)
 - 700 nA (typical) I_q with Buck Converter Enabled (No Load)
 - Configurable Load Switch or 100mA LDO Output (Load Switch by Default)
 - Up to 300-mA Charge Current for Fast Charging
 - 0.5% Accurate Battery Voltage Regulation (Configurable from 3.6 V to 4.65 V in 10-mV Steps)
 - Configurable Termination Current Down to 500 μ A
 - Simple Voltage Based Battery Monitor
- Highly Integrated Solution with Small Footprint
 - 2.5 mm x 2.5 mm WCSP Package and 6 External Components for Minimal Solution
 - Push-Button Wake-Up and Reset with Adjustable Timers
 - Power Path Management for Powering the System and Charging the Battery
 - Power Path Management enables <50 nA Ship Mode Battery Quiescent Current for Longest Shelf Life
 - Battery Charger Operates from 3.4 V – 5.5 V_{IN} (5.5-V OVP / 20-V Tolerant)
 - Dedicated Pins for Input Current Limit, Charge Current, Termination Current, and Status Output
- I²C Communication Control
 - Charge Voltage and Current
 - Termination Threshold
 - Input Current Limit
 - VINDPM Threshold
 - Timer Options
 - Load Switch Control
 - Controls for Interrupts for Faults and Status
 - System Output Voltage Adjustment
 - LDO Output Voltage Adjustment

2 Applications

- Smart Watches and other Wearable Devices
- Fitness Accessories
- Health Monitoring Medical Accessories
- Rechargeable Toys

3 Description

The bq2512x is a highly integrated battery charge management IC that integrates the most common functions for wearable devices: Linear charger, regulated output, load switch, manual reset with timer, and battery voltage monitor. The integrated buck converter is a high efficiency, low I_Q switcher using DCS control that extends light load efficiency down to 10- μ A load currents. The low quiescent current during operation and shutdown enables maximum battery life. The device supports charge currents from 5 mA to 300 mA. The input current limit, charge current, buck converter output voltage, LDO output voltage, and other parameters are programmable through the I²C interface.

Device Information⁽¹⁾

PART NUMBER	PACKAGE	BODY SIZE (NOM)
BQ2512x	DSBGA (25)	2.50 mm x 2.50 mm

(1) For all available packages, see the orderable addendum at the end of the datasheet.

Simplified Schematic

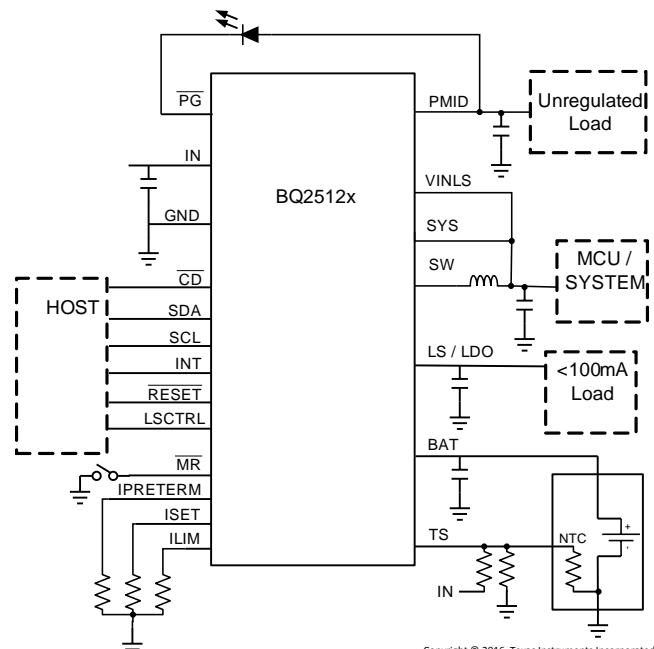

Copyright © 2016, Texas Instruments Incorporated



Table of Contents

1 Features	1	9.4 Device Functional Modes	28
2 Applications	1	9.5 Programming	31
3 Description	1	9.6 Register Maps	34
4 Revision History	2	10 Application and Implementation	45
5 Description (continued)	3	10.1 Application Information	45
6 Device Comparison Table	3	10.2 Typical Application	45
7 Pin Configuration and Functions	4	11 Power Supply Recommendations	60
8 Specifications	6	12 Layout	61
8.1 Absolute Maximum Ratings	6	12.1 Layout Guidelines	61
8.2 ESD Ratings	6	12.2 Layout Example	61
8.3 Recommended Operating Conditions	6	13 Device and Documentation Support	62
8.4 Thermal Information	7	13.1 Device Support	62
8.5 Electrical Characteristics	8	13.2 Related Links	62
8.6 Timing Requirements	12	13.3 Community Resources	62
8.7 Typical Characteristics	15	13.4 Trademarks	62
9 Detailed Description	17	13.5 Electrostatic Discharge Caution	62
9.1 Overview	17	13.6 Glossary	62
9.2 Functional Block Diagram	17	14 Mechanical, Packaging, and Orderable Information	62
9.3 Feature Description	18		

4 Revision History

NOTE: Page numbers for previous revisions may differ from page numbers in the current version.

Changes from Revision A (August 2015) to Revision B	Page
• Added BQ25121 device to data sheet	3
• Added BQ25121 device to BATTERY-PACK NTC MONITOR specs in the Electrical Characteristics table	10
• Added Figure 14 typical characteristics graph	15
• Changed text From: "... current out of ISET is 1/400 (±10%)..." To: "...current out of ISET is 1/100 (±10%)..." in Charge Current Programming by External Components (ISET) section	22

Changes from Original (August 2015) to Revision A	Page
• Changed From: Product Preview To: Production data	1

5 Description (continued)

The battery is charged using a standard Li-Ion charge profile with three phases: precharge, constant current and constant voltage. A voltage-based JEITA compatible battery pack thermistor monitoring input (TS) is included that monitors battery temperature and automatically changes charge parameters to prevent the battery from charging outside of its safe temperature range. The charger is optimized for 5-V USB input, with 20-V tolerance to withstand line transients. The buck converter is run from the input or battery. When in battery only mode, the device can run from a battery up to 4.65 V.

A configurable load switch allows system optimization by disconnecting infrequently used devices. The manual reset with timer allows multiple different configuration options for wake up reset optimization. A simple voltage based monitor provides battery level information to the host in 2% increments from 60% to 100% of the programmed $V_{(BATREG)}$.

6 Device Comparison Table

PART NUMBER	VINDPM	DEFAULT SYS OUTPUT	DEFAULT LDO OUTPUT	DEFAULT VBERG	DEFAULT CHARGE CURRENT	DEFAULT TERMINATION CURRENT	DEFAULT SHIP MODE
BQ25120	Enabled	1.8 V	Load Switch	4.2 V	10 mA	2 mA	Off
BQ25121	Enabled	2.5 V	Load Switch	4.2 V	10 mA	2 mA	Off

7 Pin Configuration and Functions

**YFP Package
25-Pin (DSBGA)
Top View**

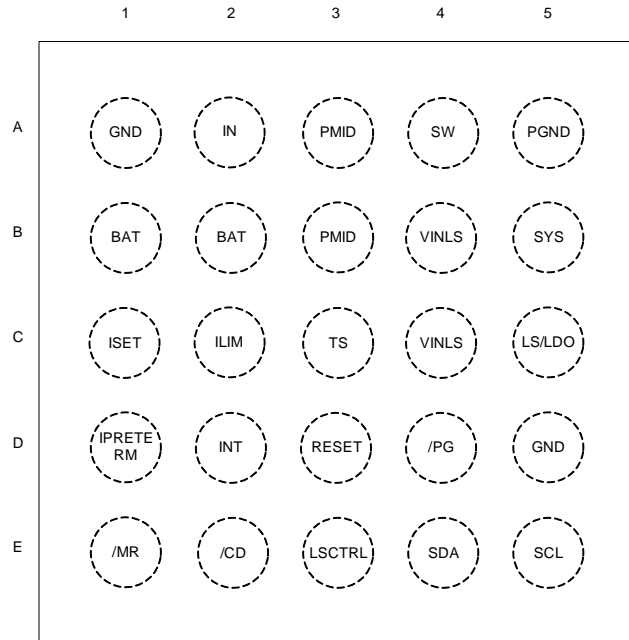

Pin Functions

PIN		I/O	DESCRIPTION
NAME	NO.		
IN	A2	I	DC Input Power Supply. IN is connected to the external DC supply. Bypass IN to GND with at least 1 μF of capacitance using a ceramic capacitor.
PMID	A3, B3	I/O	High Side Bypass Connection. Connect at least 10- μF ceramic capacitor (at least 3 μF of ceramic capacitance with DC bias derating) from PMID to GND as close to the PMID and GND pins as possible.
GND	A1, D5		Ground connection. Connect to the ground plane of the circuit.
PGND	A5		Power ground connection. Connect to the ground plane of the circuit. Connect the output filter cap from the buck converter to this ground as shown in the layout example.
$\overline{\text{CD}}$	E2	I	Chip Enable. Drive $\overline{\text{CD}}$ low to place the part in High-Z mode with battery only present, or enable charging when V_{IN} is valid. Drive $\overline{\text{CD}}$ high for Active Battery mode when battery only is present, and disable charge when V_{IN} is present. $\overline{\text{CD}}$ is pulled low internally with 900 k Ω .
SDA	E4	I/O	$I^2\text{C}$ Interface Data. Connect SDA to the logic rail through a 10-k Ω resistor.
SCL	E5	I	$I^2\text{C}$ Interface Clock. Connect SCL to the logic rail through a 10-k Ω resistor.
ILIM	C2	I	Adjustable Input Current Limit Programming. Connect a resistor from ILIM to GND to program the input current limit. The input current includes the system load and the battery charge current. Connect ILIM to GND to set the input current limit to the internal default threshold. ILIM can also be updated through $I^2\text{C}$.
LSCTRL	E3	I	Load Switch and LDO Control Input. Pull high to enable the LS/LDO output, pull low to disable the LS/LDO output.
ISET	C1	I	Fast-Charge Current Programming Input. Connect a resistor from ISET to GND to program the fast-charge current level. Connect a resistor from ISET to GND to set the charge current to the internal default. ISET can also be updated through $I^2\text{C}$. While charging, the voltage at ISET reflects the actual charging current and can be used to monitor charge current if an ISET resistor is present.

Pin Functions (continued)

PIN		I/O	DESCRIPTION
NAME	NO.		
IPRETERM	D1	I	Termination current programming input. Connect a 0-Ω to 10-kΩ resistor from IPRETERM to GND to program the termination current between 5% and 20% of the charge current. The pre-charge current is the same as the termination current setting. Connect IPRETERM to GND to set the termination current to the internal default threshold. IPRETERM can also be updated through I ² C.
INT	D2	O	Status Output. INT is an open-drain output that signals charging status and fault interrupts. INT pulls low during charging. INT is high impedance when charging is complete, disabled, or the charger is in high impedance mode. When a fault occurs, a 128μs pulse is sent out as an interrupt for the host. INT is enabled/disabled using the EN_INT bit in the control register. Connect INT to a logic rail using an LED for visual indication of charge status or through a 100kΩ resistor to communicate with the host processor.
$\overline{\text{PG}}$	D4	O	Open-drain Power Good status indication output. $\overline{\text{PG}}$ pulls to GND when V_{IN} is above $V_{(\text{BAT})} + V_{\text{SLP}}$ and less than V_{OVP} . $\overline{\text{PG}}$ is high-impedance when the input power is not within specified limits. Connect $\overline{\text{PG}}$ to the desired logic voltage rail using a 1kΩ to 100kΩ resistor, or use with an LED for visual indication. $\overline{\text{PG}}$ can also be configured as a push-button voltage shifted output (MRS) in the registers, where the output of the $\overline{\text{PG}}$ pin reflects the status of the MR input, but pulled up to the desired logic voltage rail using a 1kΩ to 100kΩ resistor.
$\overline{\text{RESET}}$	D3	O	Reset Output. $\overline{\text{RESET}}$ is an open drain active low output that goes low when $\overline{\text{MR}}$ is held low for longer than t_{RESET} , which is configurable by the MRRESET registers. $\overline{\text{RESET}}$ is deasserted after the $t_{\text{RESET_D}}$, typically 400ms.
$\overline{\text{MR}}$	E1	I	Manual Reset Input. $\overline{\text{MR}}$ is a push-button input that must be held low for greater than t_{RESET} to assert the reset output. If MR is pressed for a shorter period, there are two programmable timer events, t_{WAKE1} and t_{WAKE2} , that trigger an interrupt to the host. The $\overline{\text{MR}}$ input can also be used to bring the device out of Ship mode.
SW	A4	O	Inductor Connection. Connect to the switched side of the external inductor.
SYS	B5	I	System Voltage Sense Connection. Connect SYS to the system output at the output bulk capacitors. Bypass SYS locally with at least 4.7 μF of ceramic capacitance. The SYS rail must have at least 10 μF of total capacitance for stable operation.
LS/LDO	C5	O	Load Switch or LDO output. Connect 1 μF of ceramic capacitance to this pin to assure stability. Be sure to account for capacitance bias voltage derating when selecting the capacitor.
VINLS	B4, C4	I	Input to the Load Switch / LDO output. Connect 1 μF of ceramic capacitance from this pin to GND.
BAT	B1, B2	I/O	Battery Connection. Connect to the positive terminal of the battery. Bypass BAT to GND with at least 1 μF of ceramic capacitance. For proper operation of the device, either no battery should be connected, or the battery should be less than 0.3V, or the battery should be at least 1 V at this pin.
TS	C3	I	Battery Pack NTC Monitor. Connect TS to the center tap of a resistor divider from the system output to GND. The NTC is connected from TS to GND. The TS function provides four thresholds for JEITA compatibility. TS faults are reported by the I ² C interface during charge mode.

8 Specifications

8.1 Absolute Maximum Ratings

over operating free-air temperature range (unless otherwise noted) ⁽¹⁾

		MIN	MAX	UNIT	
Input voltage	IN	wrt GND	-0.3	20	V
	PMID, VINLS	wrt GND	-0.3	7.7	V
	$\overline{\text{CDSDA}}$, $\overline{\text{SCL}}$, $\overline{\text{ILIM}}$, $\overline{\text{ISET}}$, $\overline{\text{IPRETERM}}$, $\overline{\text{LSCTRL}}$, $\overline{\text{INT}}$, $\overline{\text{RESET}}$, $\overline{\text{TS}}$	wrt GND	-0.3	5.5	V
Output voltage	SYS		3.6	V	
Input current	IN		400	mA	
Sink current	INT		10	mA	
Sink/Source Current	$\overline{\text{RESET}}$		10	mA	
Output Voltage Continuous	SW	-0.7	7.7	V	
Output Current Continuous	SW		400	mA	
	SYS, BAT		300	mA	
Current	LS/LDO		150	mA	
BAT Operating Voltage	VBAT, MR,		6.6	V	
Junction Temperature		-40	125	°C	
Storage Temperature, T _{stg}			300	°C	

- (1) Stresses beyond those listed under *Absolute Maximum Ratings* may cause permanent damage to the device. These are stress ratings only, which do not imply functional operation of the device at these or any other conditions beyond those indicated under *Recommended Operating Conditions*. Exposure to absolute-maximum-rated conditions for extended periods may affect device reliability.

8.2 ESD Ratings

			VALUE	UNIT
V _(ESD)	Electrostatic discharge	Human body model (HBM), per ANSI/ESDA/JEDEC JS-001 ⁽¹⁾	±2000	V
		Charged device model (CDM), per JEDEC specification JESD22-C101 ⁽²⁾	±500	

- (1) JEDEC document JEP155 states that 500-V HBM allows safe manufacturing with a standard ESD control process.
 (2) JEDEC document JEP157 states that 250-V CDM allows safe manufacturing with a standard ESD control process.

8.3 Recommended Operating Conditions

over operating free-air temperature range (unless otherwise noted)

		MIN	NOM	MAX	UNIT
V _{IN}	IN voltage range	3.4	5	20	V
	IN operating voltage range, recommended	3.4	5	5.5	
V _(BAT)	V _(BAT) operating voltage range			5.5 ⁽¹⁾	V
V _(VINLS)	VINLS voltage range for Load Switch	0.8		5.5 ⁽²⁾	V
V _(VINLS)	VINLS voltage range for LDO	2.2		5.5	V
I _{IN}	Input Current, IN input			400	mA
I _(SW)	Output Current from SW, DC			300	mA
I _(PMID)	Output Current from PMID, DC			300	mA
ILS/LDO	Output Current from LS/LDO			100	mA
I _(BAT) , I _(SYS)	Charging and discharging using internal battery FET			300	mA
T _J	Operating junction temperature range	-40		125	°C

- (1) Any voltage greater than shown should be a transient event.
 (2) These inputs will support 6.6 V for less than 10% of the lifetime at V_(BAT) or V_{IN}, with a reduced current and/or performance.

8.4 Thermal Information

THERMAL METRIC ⁽¹⁾		bq25120		UNIT
		YFP (DSBGA)		
		25 PINS		
$R_{\theta JA}$	Junction-to-ambient thermal resistance	60		°C/W
$R_{\theta JC(top)}$	Junction-to-case (top) thermal resistance	0.3		
$R_{\theta JB}$	Junction-to-board thermal resistance	12.0		
ψ_{JT}	Junction-to-top characterization parameter	1.2		
ψ_{JB}	Junction-to-board characterization parameter	12.0		
$R_{\theta JC(bot)}$	Junction-to-case (bottom) thermal resistance	N/A		

(1) For more information about traditional and new thermal metrics, see the *IC Package Thermal Metrics* application report, [SPRA953](#).

8.5 Electrical Characteristics

Circuit of [Figure 1](#), $V_{(UVLO)} < V_{IN} < V_{(OCP)}$ and $V_{IN} > V_{(BAT)} + V_{(SLP)}$, $T_J = -40$ to 85°C and $T_J = 25^\circ\text{C}$ for typical values (unless otherwise noted)

PARAMETERS		TEST CONDITIONS	MIN	TYP	MAX	UNIT
INPUT CURRENTS						
I_{IN}	Supply Current for Control	$V_{(UVLO)} < V_{IN} < V_{(OVP)}$ and $V_{IN} > V_{(BAT)} + V_{(SLP)}$ PWM Switching, $-40 < T_J < 85$		1		mA
		$V_{(UVLO)} < V_{IN} < V_{(OVP)}$ and $V_{IN} > V_{(BAT)} + V_{(SLP)}$ PWM NOT Switching			3	mA
		$0^\circ\text{C} < T_J < 85^\circ\text{C}$, $V_{IN} = 5\text{ V}$, Charge Disabled			1.5	mA
$I_{(BAT_HIZ)}$	Battery discharge current in High Impedance Mode	$0^\circ\text{C} < T_J < 60^\circ\text{C}$, $V_{IN} = 0\text{ V}$, High-Z Mode, PWM Not Switching, $V_{(BUVLO)} < V_{(BAT)} < 4.65\text{ V}$		0.7	1.2	μA
		$0^\circ\text{C} < T_J < 60^\circ\text{C}$, $V_{IN} = 0\text{ V}$, High-Z Mode, PWM Not Switching, $V_{(BUVLO)} < V_{(BAT)} < 6.6\text{ V}$		0.9	1.5	μA
		$0^\circ\text{C} < T_J < 60^\circ\text{C}$, $V_{IN} = 0\text{ V}$ or floating, High-Z Mode, PWM Switching, No Load		0.75	3.5	μA
		$0^\circ\text{C} < T_J < 85^\circ\text{C}$, $V_{IN} = 0\text{ V}$, High-Z Mode, PWM Switching, LSLDO enabled		1.35	4.25	μA
$I_{(BAT_ACTIVE)}$	Battery discharge current in Active Battery Mode	$0^\circ\text{C} < T_J < 85^\circ\text{C}$, $V_{IN} = 0\text{ V}$, Active Battery Mode, PWM Switching, LSLDO enabled, I2C Enabled, $V_{(BUVLO)} < V_{(BAT)} < 4.65\text{ V}$		6.8	12	μA
		$0^\circ\text{C} < T_J < 85^\circ\text{C}$, $0 < V_{IN} < V_{(UVLO)}$, Active Battery Mode, PWM Switching, LSLDO disabled, I2C Enabled, /CD = Low, $V_{(BUVLO)} < V_{(BAT)} < 4.65\text{ V}$		6.2	11	μA
$I_{(BAT_SHIP)}$	Battery discharge current in Ship Mode	$0^\circ\text{C} < T_J < 85^\circ\text{C}$, $V_{IN} = 0\text{ V}$, Ship Mode		2	150	nA
POWER-PATH MANAGEMENT and INPUT CURRENT LIMIT						
$V_{DO(IN-PMID)}$	$V_{IN} - V_{(PMID)}$	$V_{IN} = 5\text{ V}$, $I_{IN} = 300\text{ mA}$		125	170	mV
$V_{DO(BAT-PMID)}$	$V_{(BAT)} - V_{(PMID)}$	$V_{IN} = 0\text{ V}$, $V_{(BAT)} > 3\text{ V}$, $I_{ff} = 400\text{ mA}$		120	160	mV
$V_{(BSUP1)}$	Enter supplement mode threshold	$V_{(BAT)} > V_{(BUVLO)}$		$V_{(PMID)} < V_{(BAT)} - 25\text{ mV}$		V
$V_{(BSUP2)}$	Exit supplement mode threshold	$V_{(BAT)} > V_{(BUVLO)}$		$V_{(PMID)} < V_{(BAT)} - 5\text{ mV}$		V
$I_{(BAT_OCP)}$	Current Limit, Discharge Mode	$V_{(BAT)} > V_{(BUVLO)}$	0.85	1.15	1.35	A
$I_{(ILIM)}$	Input Current Limit	Programmable Range, 50-mA steps	50		400	mA
	Maximum Input Current using ILIM			$K_{(ILIM)} / R_{(ILIM)}$		
	I_{ILIM} accuracy I_{ILIM} accuracy	50 mA to 100 mA 100 mA to 400 mA	-12% -5%		12% 5%	
$K_{(ILIM)}$	Maximum input current factor	$I_{(ILIM)} = 50\text{ mA}$ to 100 mA	175	200	225	AQ
		$I_{(ILIM)} = 100\text{ mA}$ to 400 mA	190	200	210	AQ
$V_{(IN(DPM))}$	Input voltage threshold when input current is reduced	Programmable Range using $V_{(IN(DPM))}$ Registers. Can be disabled using $V_{(IN(DPM_ON))}$	4.2		4.9	V
	$V_{(IN_DPM)}$ threshold accuracy		-3%		3%	
BATTERY CHARGER						
$V_{D(PPM)}$	PMID voltage threshold when charge current is reduced	Above $V_{(BATREG)}$		0.2		V
$R_{ON(BAT-PMID)}$	Internal Battery Charger MOSFET on-resistance	Measured from BAT to PMID, $V_{(BAT)} = 4.35\text{ V}$, High-Z mode		300	400	m Ω
$V_{(BATREG)}$	Charge Voltage	Operating in voltage regulation, Programmable Range, 10mV steps	3.6		4.65	V
	Voltage Regulation Accuracy	$T_J = 25^\circ\text{C}$	-0.5%		0.5%	
		$T_J = 0^\circ\text{C}$ to 85°C	-0.5%		0.5%	

Electrical Characteristics (continued)

Circuit of , $V_{(UVLO)} < V_{IN} < V_{(OCP)}$ and $V_{IN} > V_{(BAT)} + V_{(SLP)}$, $T_J = -40$ to 85°C and $T_J = 25^\circ\text{C}$ for typical values (unless otherwise noted)

PARAMETERS		TEST CONDITIONS	MIN	TYP	MAX	UNIT
$I_{(CHARGE)}$	Fast Charge Current Range	$V_{(BATUVLO)} < V_{(BAT)} < V_{(BATREG)}$	5		300	mA
	Fast Charge Current using ISET			$K_{(ISET)} / R_{(ISET)}$		A
	Fast Charge Current Accuracy		-5%		5%	
$K_{(ISET)}$	Fast Charge Current Factor	$5 \text{ mA} > I_{(CHARGE)} > 300 \text{ mA}$	190	200	210	AΩ
$I_{(TERM)}$	Termination charge current	Termination current programmable range over $I^2\text{C}$	0.5		37	mA
	Termination Current using IPRETERM	$I_{(CHARGE)} < 300 \text{ mA}$, $R_{(ITERM)} = 15 \text{ k}\Omega$		5		% of I_{SET}
		$I_{(CHARGE)} < 300 \text{ mA}$, $R_{(ITERM)} = 4.99 \text{ k}\Omega$		10		% of I_{SET}
		$I_{(CHARGE)} < 300 \text{ mA}$, $R_{(ITERM)} = 1.65 \text{ k}\Omega$		15		% of I_{SET}
		$I_{(CHARGE)} < 300 \text{ mA}$, $R_{(ITERM)} = 549 \Omega$		20		% of I_{SET}
Accuracy		-10%		10%		
$t_{DGL(TERM)}$	TERM deglitch time	Both rising and falling, 2-mV over-drive, t_{RISE} , $t_{FALL} = 100 \text{ ns}$		64		ms
$I_{(PRE_CHARGE)}$	Pre-charge current	Pre-charge current programmable range over $I^2\text{C}$	0.5		37	mA
	Pre-charge Current using IPRETERM			$I_{(TERM)}$		A
	Accuracy		-10%		10%	
$V_{(RCH)}$	Recharge threshold voltage	Below $V_{(BATREG)}$	100	120	140	mV
$t_{DGL(RCHG)}$	Recharge threshold deglitch time	$t_{FALL} = 100 \text{ ns typ}$, $V_{(RCH)}$ falling		32		ms
SYS OUTPUT						
$R_{DS(ON_HS)}$		PMID = 3.6 V, $I_{(SYS)} = 50 \text{ mA}$		675	850	mΩ
$R_{DS(ON_LS)}$		PMID = 3.6 V, $I_{(SYS)} = 50 \text{ mA}$		300	475	mΩ
$R_{DS(CH_SYS)}$	MOSFET on-resistance for SYS discharge	$V_{IN} = 3.6 \text{ V}$, $I_{OUT} = -10 \text{ mA}$ into V_{OUT} pin		22	40	Ω
$I_{(LIMF)}$	SW Current limit HS	$2.2\text{V} < V_{(PMID)} < 5.5 \text{ V}$	525	600	675	mA
	SW Current limit LS	$2.2\text{V} < V_{(PMID)} < 5.5 \text{ V}$	525	700	850	mA
I_O	DC Output Current			200	300	mA
$I_{(LIM_SS)}$	PMOS switch current limit during softstart	Current limit is reduced during softstart	80	130	200	mA
V_{SYS}	SYS Output Voltage Range	Programmable range, 100 mV Steps	1.1		3.3	V
	Output Voltage Accuracy	$V_{IN} = 5 \text{ V}$, PFM mode, $I_{OUT} = 10 \text{ mA}$, $V_{(SYS)} = 1.8 \text{ V}$	-2.5%	0	2.5%	
	DC Output Voltage Load Regulation in PWM mode	$V_{OUT} = 2 \text{ V}$, Load range		0.01		%/mA
	DC Output Voltage Line Regulation in PWM mode	$V_{OUT} = 2 \text{ V}$, $I_{OUT} = 100 \text{ mA}$, V_{IN} RANGE		0.01		%/V
LS/LDO OUTPUT						
$V_{IN(LS)}$	Input voltage range for LS/LDO	Load Switch Mode	0.8		6.6	V
	Input voltage range for LS/LDO	LDO Mode	2.2		6.6	V
V_{OUT}	DC output accuracy	$T_J = 25^\circ\text{C}$	-2%	±1%	2%	
		Over V_{IN} , I_{OUT} , temperature	-3%	±2%	3%	
V_{LDO}	Output range for LS/LDO	Programmable Range, 0.1 V steps	0.8		3.3	V
$\Delta V_{OUT} / \Delta V_{IN}$	DC Line regulation	$V_{OUT(NOM)} + 0.5 \text{ V} < V_{IN} < 6.6 \text{ V}$, $I_{OUT} = 5 \text{ mA}$	-1%		1%	
	DC Load regulation	$0 \text{ mA} < I_{OUT} < 100 \text{ mA}$	-1%		1%	
	Load Transient	$2 \mu\text{A}$ to 100 mA , $V_{OUT} = 1.8 \text{ V}$	-120		60	mV
$R_{DS(ON_LDO)}$	FET Rdson	$V_{(VINLS)} = 3.6 \text{ V}$		460	600	mΩ

Electrical Characteristics (continued)

Circuit of , $V_{(UVLO)} < V_{IN} < V_{(OCP)}$ and $V_{IN} > V_{(BAT)} + V_{(SLP)}$, $T_J = -40$ to 85°C and $T_J = 25^\circ\text{C}$ for typical values (unless otherwise noted)

PARAMETERS	TEST CONDITIONS	MIN	TYP	MAX	UNIT		
$R_{(DSCH_LSLDO)}$	MOSFET on-resistance for LS/LDO discharge	1.7V < $V_{(VINLS)} < 6.6$ V, $I_{LOAD} = -10$ mA			30	Ω	
$I_{(OCL_LDO)}$	Output Current Limit – LDO	$V_{LS/LDO} = 0.9 \times V_{LS/LDO(NOM)}$		275	365	450	mA
$I_{(LS/LDO)}$	Output Current	$V_{(VINLS)} = 3.6$ V, $V_{LSLDO} = 3.3$ V				100	mA
		$V_{(VINLS)} = 3.3$ V, $V_{LSLDO} = 0.8$ V				100	mA
		$V_{(VINLS)} = 2.2$ V, $V_{LSLDO} = 0.8$ V				10	mA
$I_{IN(LDO)}$	Quiescent current for VINLS in LDO mode				0.9		μA
	OFF-state supply current				0.25		μA
$V_{IH(LSCTRL)}$	High-level input voltage for LSCTRL	1.15 V > $V_{(VINLS)} > 6.6$ V		0.75 x $V_{(SYS)}$		6.6	V
$V_{IL(LSCTRL)}$	Low-level input voltage for LSCTRL	1.15 V > $V_{(VINLS)} > 6.6$ V				0.25 x $V_{(SYS)}$	V
PUSHBUTTON TIMER (\overline{MR})							
V_{IL}	Low-level input voltage					0.3	V
R_{PU}	Internal pull-up resistance				120		k Ω
VBAT MONITOR							
V_{BMON}	Battery Voltage Monitor Accuracy	$V_{(BAT)}$ Falling - Including 2% increment		-3.5		3.5	% $V_{(BATREG)}$
BATTERY-PACK NTC MONITOR							
V_{HOT}	High temperature threshold	V_{TS} falling, 1% V_{IN} Hysteresis	bq25120	14.5	15	15.2	% V_{IN}
			bq25121				
V_{WARM}	Warm temperature threshold	V_{TS} falling, 1% V_{IN} Hysteresis	bq25120	20.1	20.5	20.8	% V_{IN}
			bq25121				
V_{COOL}	Cool temperature threshold	V_{TS} rising, 1% V_{IN} Hysteresis	bq25120	35.4	36	36.4	% V_{IN}
			bq25121				
V_{COLD}	Low temperature threshold	V_{TS} rising, 1% V_{IN} Hysteresis	bq25120	39.3	39.8	40.2	% V_{IN}
			bq25121				
TS_{OFF}	TS Disable threshold	V_{TS} rising, 2% V_{IN} Hysteresis	bq25120	55		60	% V_{IN}
			bq25121				
PROTECTION							
$V_{(UVLO)}$	IC active threshold voltage	V_{IN} rising		3.4	3.6	3.8	V
$V_{(UVLO(HYS))}$	IC active hysteresis	V_{IN} falling from above $V_{(UVLO)}$			150		mV
$V_{(BUVLO)}$	Battery Undervoltage Lockout threshold Range	Programmable Range for $V_{(BUVLO)}$ VBAT falling, 200 mV Hysteresis		2.2		3.0	V
	Default Battery Undervoltage Lockout Accuracy	$V_{(BAT)}$ falling		-2.5%		2.5%	
$V_{(BATSHORT)}$	Battery short circuit threshold	Battery voltage falling			2		V
$V_{(BATSHORT_HYS)}$	Hysteresis for $V_{(BATSHORT)}$				100		mV
$I_{(BATSHORT)}$	Battery short circuit charge current				$I_{(PRETERM)}$		mA
$V_{(SLP)}$	Sleep entry threshold, $V_{IN} - V_{(BAT)}$	2 V < $V_{BAT} < V_{(BATREG)}$, V_{IN} falling			65	120	mV
$V_{(SLP_HYS)}$	Sleep-mode exit hysteresis	V_{IN} rising above $V_{(SLP)}$		40	65	100	mV
V_{OVP}	Maximum Input Supply OVP threshold voltage	V_{IN} rising, 100 mV hysteresis		5.35	5.55	5.75	V
t_{DGL_OVP}	Deglintch time, VIN OVP falling	V_{IN} falling below V_{OVP} , 1V/us			32		ms
T_{SHTDWN}	Thermal trip	$V_{IN} > V_{UVLO}$			114		$^\circ\text{C}$

Electrical Characteristics (continued)

Circuit of , $V_{(UVLO)} < V_{IN} < V_{(OCP)}$ and $V_{IN} > V_{(BAT)} + V_{(SLP)}$, $T_J = -40$ to 85°C and $T_J = 25^\circ\text{C}$ for typical values (unless otherwise noted)

PARAMETERS		TEST CONDITIONS	MIN	TYP	MAX	UNIT
T_{HYS}	Thermal hysteresis	$V_{IN} > V_{UVLO}$		11		$^\circ\text{C}$
t_{DGL_SHTDWN}	Deglintch time, Thermal shutdown	T_J rising above T_{SHTDWN}		4		μs
I2C INTERFACE						
	I ² C Bus Specification standard and fast mode frequency support		100		400	kHz
V_{IL}	Input low threshold level	$V_{PULLUP} = 1.1\text{ V}$, SDA and SCL			0.275	V
V_{IH}	Input high threshold level	$V_{PULLUP} = 1.1\text{ V}$, SDA and SCL	0.825			V
V_{IH}	Input high threshold level	$V_{PULLUP} = 3.3\text{ V}$, SDA and SCL	2.475			V
V_{OL}	Output low threshold level	$I_L = 5\text{ mA}$, sink current, $V_{PULLUP} = 1.1\text{ V}$			0.275	V
I_{BIAS}	High-Level leakage current	$V_{PULLUP} = 1.8\text{ V}$, SDA and SCL			1	μA
INT, $\overline{\text{PG}}$, and $\overline{\text{RESET}}$ OUTPUT (Open Drain)						
V_{OL}	Low level output threshold	Sinking current = 5 mA			$0.25 \times V_{(SYS)}$	V
I_{IN}	Bias current into pin	Pin is high impedance, $I_{OUT} = 0\text{ mA}$		0	12	nA
$V_{IN(BAT_DELTA)}$	Input voltage above VBAT where $\overline{\text{PG}}$ sends two 128 μs pulses each minute to signal the host of the input voltage status	$V_{UVLO} < V_{IN} < V_{OVP}$	0.825	1	1.15	V
INPUT PIN ($\overline{\text{CD}}$ LSCTRL)						
$V_{IL}(\overline{\text{CD_LSCTRL}})$	Input low threshold	$V_{(PULLUP)} = 1\text{ V}$			0.25	V
$V_{IH}(\overline{\text{CD_LSCTRL}})$	Input high threshold	$V_{(PULLUP)} = 1\text{ V}$	0.75			V
$R_{PULLDOWN/CD}$	Internal pull-down resistance			900		k Ω
$R_{(LSCTRL)}$	Internal pull-down resistance			2		M Ω

8.6 Timing Requirements

			MIN	TYP	MAX	UNIT
POWER-PATH MANAGEMENT AND INPUT CURRENT LIMIT						
t_{DGL_SC}	Deglitch Time, PMD or SW Short Circuit during Discharge Mode			250		μs
t_{REC_SC}	Recovery time, OUT Short Circuit during Discharge Mode			2		s
BATTERY CHARGER						
t_{DGL_SHORT}	Deglitch time transition from ISET short to $I_{(CHARGE)}$ disable	Clear fault by disconnecting VIN		1		ms
BATTERY CHARGING TIMERS						
t_{MAXCHG}	Charge safety timer	Programmable range	2		540	min
t_{PRECHG}	Precharge safety timer			$0.1 \times t_{MAXCHG}$		
SYS OUTPUT						
t_{ONMIN}	Minimum ON time	$V_{IN} = 3.6 V, V_{OUT} = 2V, I_{OUT} = 0 mA$		225		ns
t_{OFFMIN}	Minimum OFF time	$V_{IN} = 4.2 V$		50		ns
t_{START_SW}	SW start up time	$V_{IN} = 5 V$, from write on EN_SW_OUT until output starts to rise		5	25	ms
t_{START_SYS}	SYS output time to start switching	From insertion of $BAT > V_{(BUVLO)}$ or $V_{IN} > V_{(UVLO)}$		350		μs
$t_{SOFTSTART}$	Softstart time with reduced current limit			400	1200	μs
LS/LDO OUTPUT						
t_{ON_LDO}	Turn ON time	100mA load		500		μs
t_{OFF_LDO}	Turn OFF time	100mA load		5		μs
PUSHBUTTON TIMER						
t_{WAKE1}	Push button timer wake 1	Programmable Range for wake1 function	0.05		1	s
t_{WAKE2}	Push button timer wake 2	Programmable Range for wake2 function	1		2	s
t_{RESET}	Push button timer reset	Programmable Range for reset function	8		14	s
t_{RESET_D}	Reset pulse duration			400		ms
t_{DD}	Detection delay (from MR, input to RESET)	For 0s condition		6		μs
BATTERY-PACK NTC MONITOR						
$t_{DGL(TS)}$	Deglitch time on TS change	Applies to $V_{(HOT)}$, $V_{(WARM)}$, $V_{(COOL)}$, and $V_{(COLD)}$		50		ms
I2C INTERFACE						
$t_{WATCHDOG}$	I2C interface reset timer for host			50		s
$t_{I2CRESET}$	I2C interface inactive reset timer			700		ms
$t_{HiZ_ACTIVEBAT}$	Transition time required to enable the I2C interface from HiZ to Active BAT				1	ms
INPUT PIN						
t_{CD_DGL}	Deglitch for \overline{CD}	\overline{CD} rising/falling		100		μs

Typical Start-Up Timing and Operation

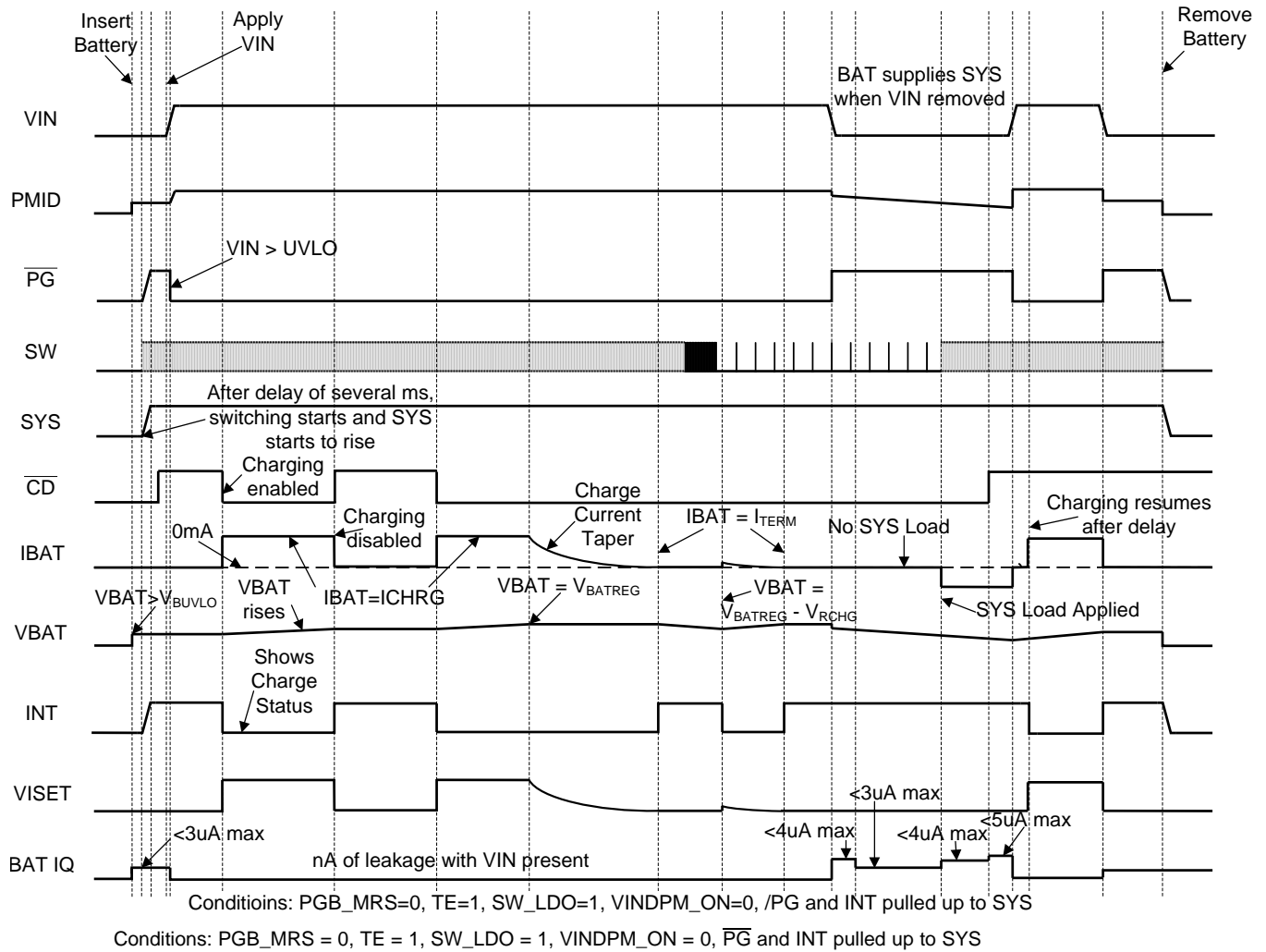

Figure 1. Typical Start-Up Timing and Operation

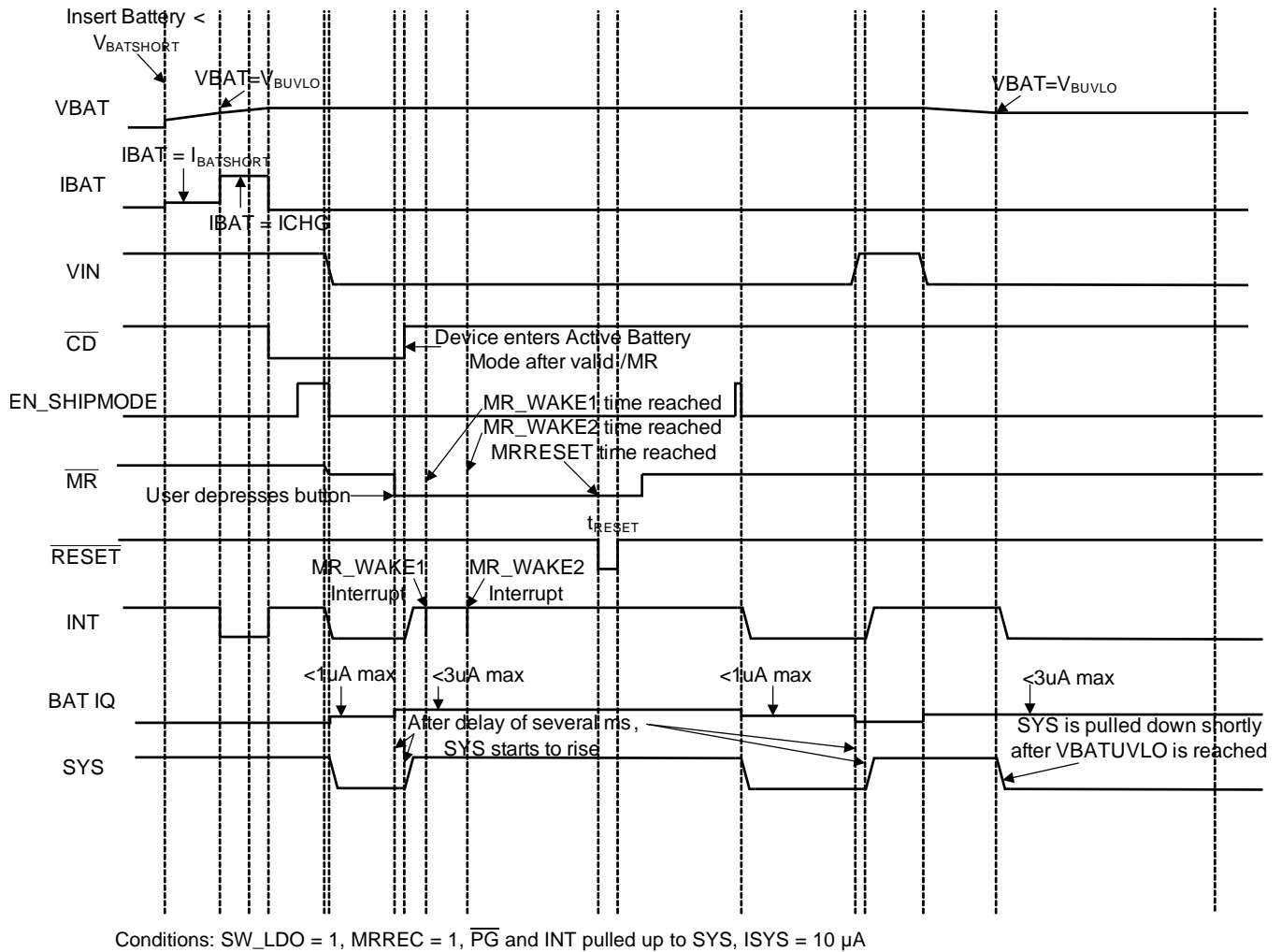
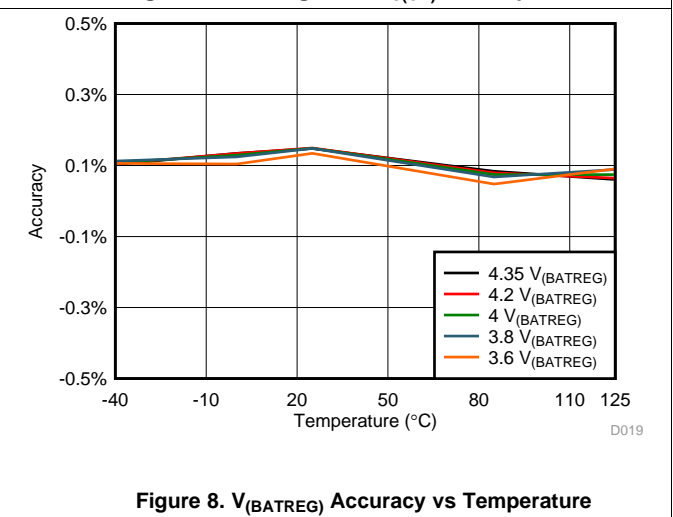
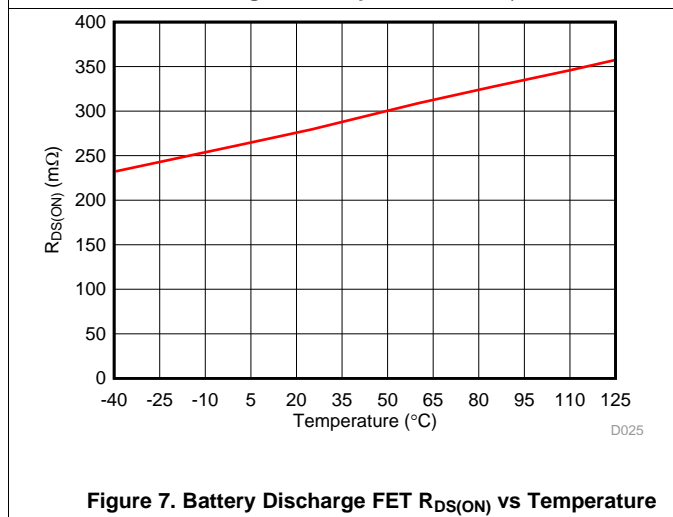
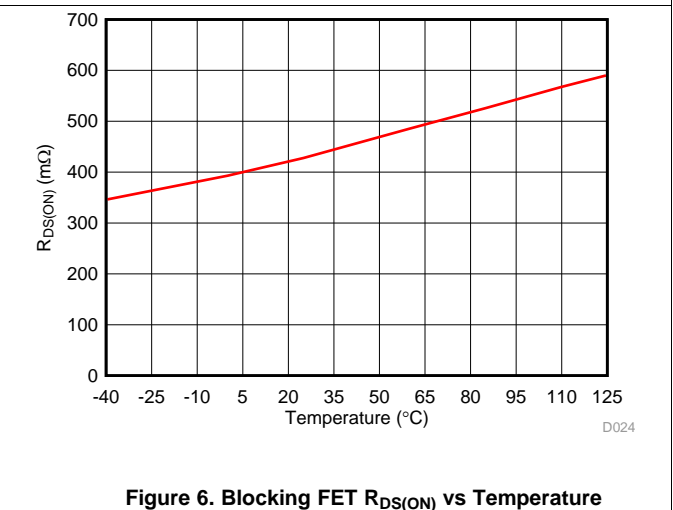
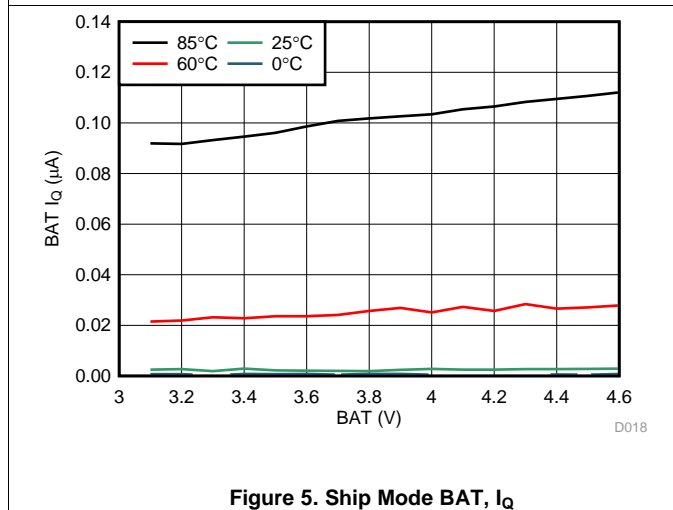
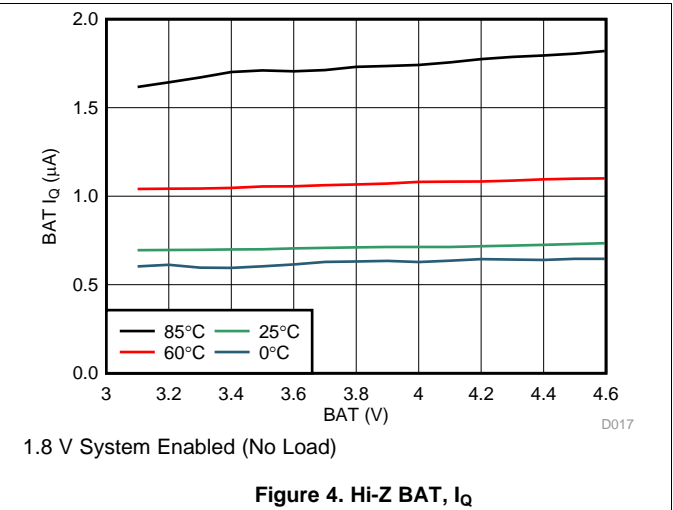
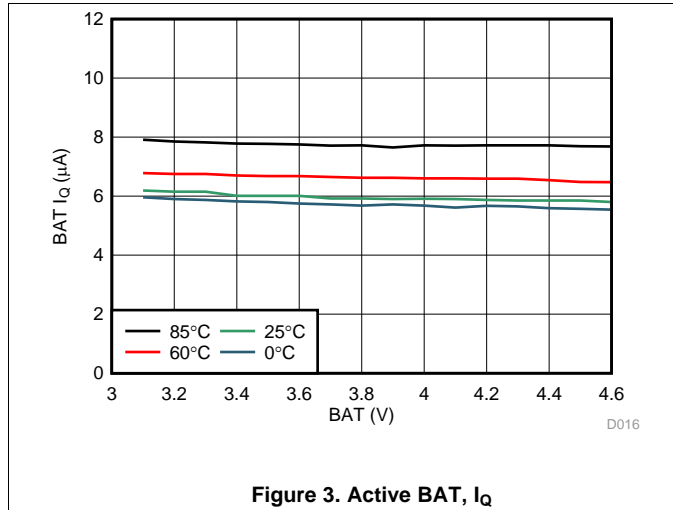

Figure 2. Battery Operation and Sleep Mode

8.7 Typical Characteristics



Typical Characteristics (continued)

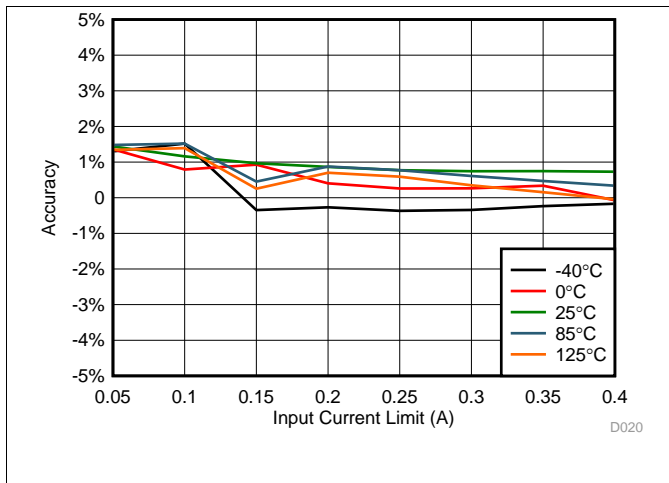

Figure 9. ILIM Accuracy vs Input Current

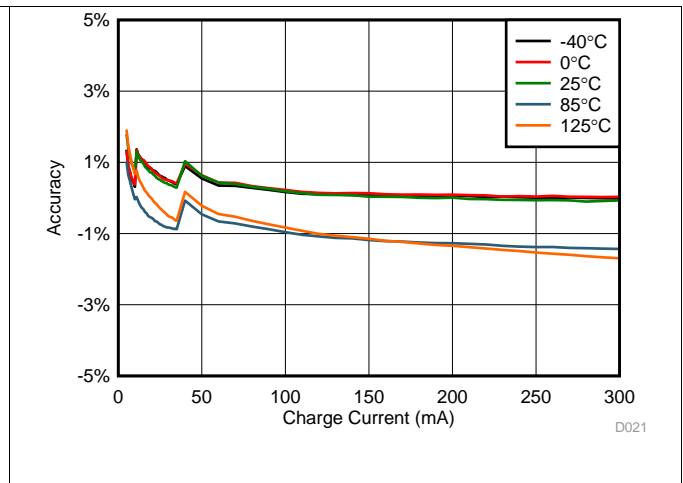

Figure 10. Charge Current Accuracy vs Charge Current

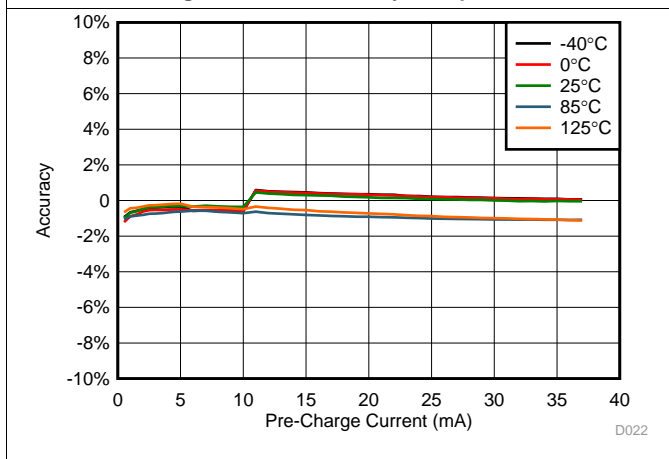

Figure 11. Pre-Charge Accuracy vs Pre-Charge Current

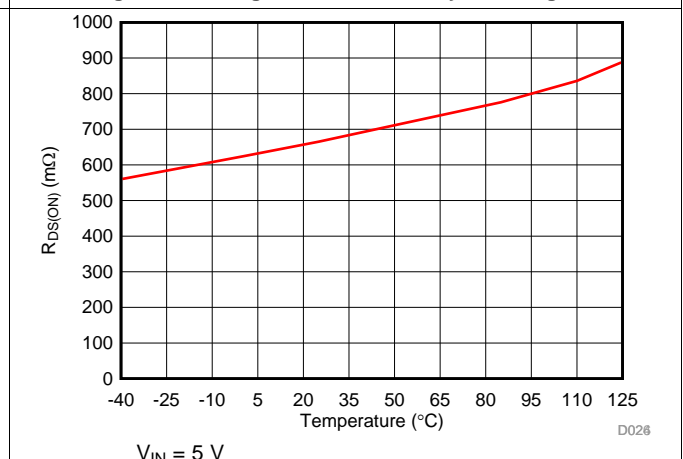

Figure 12. $R_{DS(ON)}$ of High Side MOSFET vs Temperature

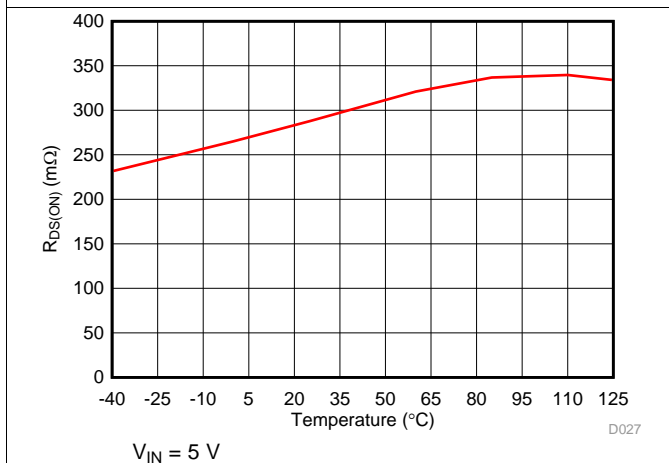

Figure 13. $R_{DS(ON)}$ of Low Side MOSFET vs Temperature

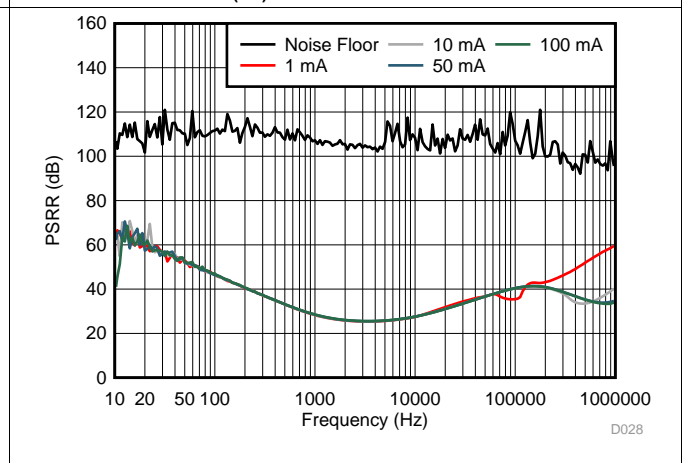

Figure 14. LS/LDO PSRR vs Frequency

9 Detailed Description

9.1 Overview

The following sections describe in detail the functions provided by the BQ25120. These include linear charger, PWM output, configurable LS/LDO output, Push-button input, reset timer, functional modes, battery monitor, I²C configurability and functions, and safety features.

9.2 Functional Block Diagram

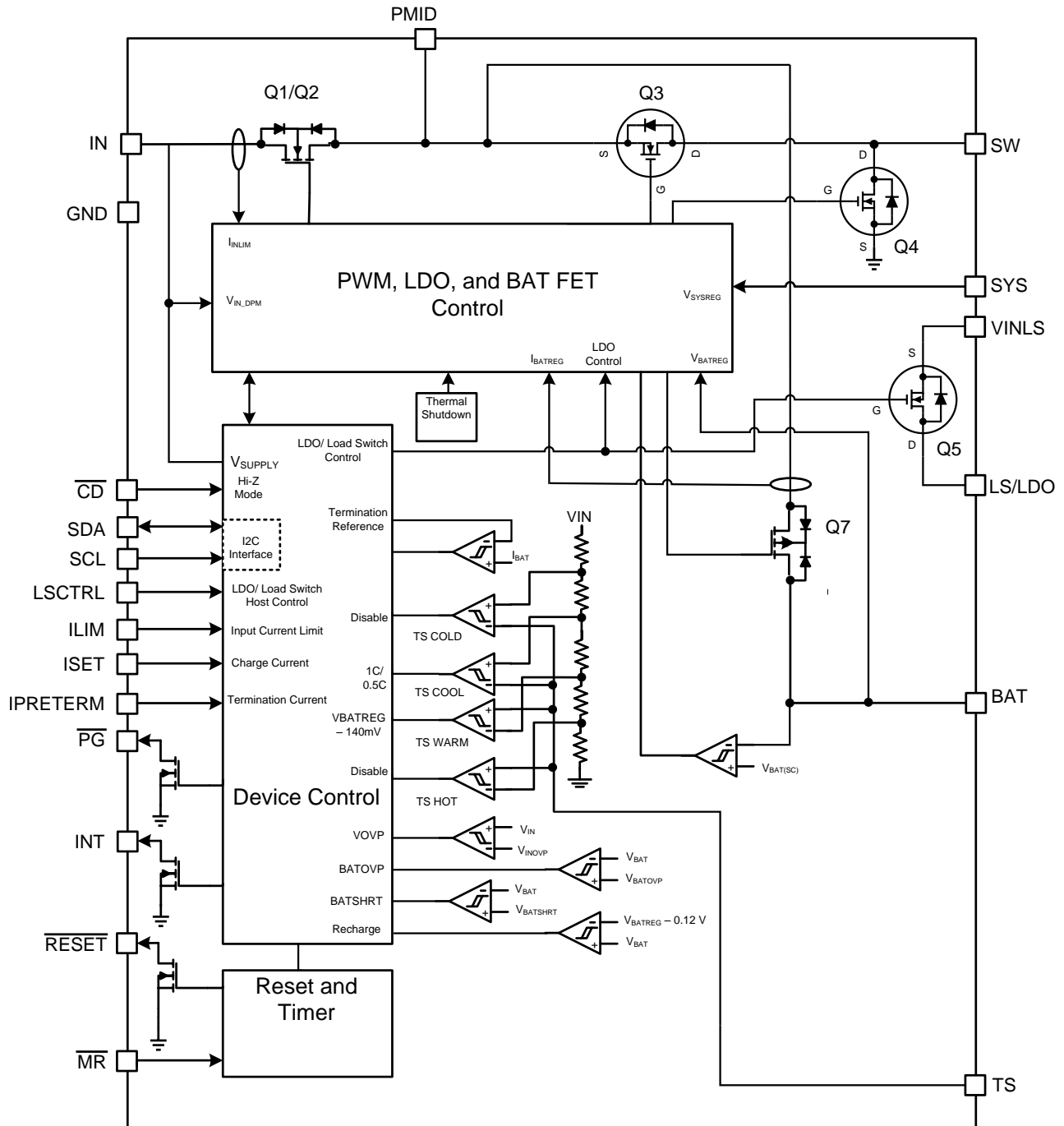

Copyright © 2016, Texas Instruments Incorporated

9.3 Feature Description

9.3.1 Ship Mode

Ship Mode is the lowest quiescent current state for the device. Ship Mode latches off the device and BAT FET until $V_{IN} > V_{UVLO}$ or the \overline{MR} button is depressed for t_{WAKE1} and released. To enter Ship Mode, \overline{CD} must be pulled high. If the EN_SHIPMODE is written to a 1 while the input is connected, it must first be removed to enter ship mode. This allows the end product with minimal load on the battery, and the end user will enable the device by plugging it into the adapter or by toggling the \overline{MR} button or both depending on the register settings. The battery voltage must be above the maximum programmable BUUVLO threshold in order to exit Ship mode. The EN_SHIPMODE bit can be cleared using the I²C interface as well while the input is valid. The following list shows the events that are active during Ship Mode:

1. VIN_UV Comparator
2. \overline{MR} Input (No clock or delay in this mode for lowest power consumption)

9.3.2 High Impedance Mode

High Impedance mode is the lowest quiescent current state while operating from the battery. During Hi-Z mode the SYS output is powered by BAT, the \overline{MR} input is active, and the LSCTRL input is active. All other circuits are in a low power or sleep state. The LS/LDO output can be enabled in Hi-Z mode with the LSCTRL input. If the LS/LDO output has been enabled through I²C prior to entering Hi-Z mode, it will stay enabled. The \overline{CD} pin is used to put the device in a high-impedance mode when battery is present and $V_{IN} < V_{UVLO}$. Drive \overline{CD} high to enable the device and enter active battery operation when V_{IN} is not valid. When the HZ_MODE bit is written by the host, the I²C interface is disabled if only battery is present. To resume I²C, the \overline{CD} pin must be toggled. The functionality is shown in [Table 1](#).

Table 1. CD, State Table

CD, State	$V_{IN} < V_{UVLO}$	$V_{IN} > V_{UVLO}$
L	Hi-Z	Charge Enabled
H	Active Battery	Charge Disabled

9.3.3 Active Battery Only Connected

When the battery above $V_{BATUVLO}$ is connected with no input source, the battery discharge FET is turned on. After the battery rises above $V_{BATUVLO}$ and the deglitch time is reached, the SYS output starts to rise. The current from PMID and SYS is not regulated, but is protected by a short circuit current limit. If the short circuit limit is reached for the deglitch time (t_{DGL_SC}), the battery discharge FET is turned off for the recovery time (t_{REC_SC}). After the recovery time, the battery FET is turned on to test if the short has been removed. If it has not, the FET turns off and the process repeats until the short is removed. This process protects the internal FET from over current. During this event PMID will likely droop and cause SYS to go out of regulation. After SYS recovers, it is recommended that the host read the Faults Register to determine the cause of the event.

To provide designers the most flexibility in optimizing their system, an adjustable BATUVLO is provided. Deeper discharge of the battery enables longer times between charging, but may shorten the battery life. The BATUVLO is adjustable with a fixed 100-mV hysteresis.

If a valid V_{IN} is connected during active battery mode, $V_{IN} > V_{UVLO}$, the supplement and battery discharge FET is turned on when the battery voltage is above the minimum $V_{BATUVLO}$.

Drive \overline{CD} high or write the CE register to disable charge when $V_{IN} > V_{UVLO}$ is present. \overline{CD} is internally pulled down. When exiting this mode, charging resumes if V_{IN} is present, \overline{CD} is low and charging is enabled.

All HOST interfaces (\overline{CD} , SDA/SCL, INT, \overline{RESET} and LSCTRL) are active no later than 5 ms after SYS reaches the programmed level.

9.3.4 Voltage Based Battery Monitor

The device implements a simple voltage battery monitor which can be used to determine the depth of discharge. Prior to entering High-Z mode, the device will initiate a VBMON reading. The host can read the latched value for the no-load battery voltage, or initiate a reading using VBMON_READ to see the battery voltage under a known load. The register will be updated and can be read 2ms after a read is initiated. The VBMON voltage threshold is readable with 2% increments with $\pm 1.5\%$ accuracy between 60% and 100% of VBATREG using the VBMON_TH registers. Reading the value during charge is possible, but for the most accurate battery voltage indication, it is recommended to disable charge, initiate a read, and then re-enable charge.

A typical discharge profile for a Li-Ion battery is shown in Table 2. The specific battery to be used in the application should be fully characterized to determine the thresholds that will indicate the appropriate battery status to the user. Two typical examples are shown below, assuming the VBMON reading is taken with no load on the battery.

This function enables a simple 5-bar status indicator with the following typical performance with different VBATREG settings:

Table 2. Discharge Profile for a Li-Ion Battery

VBATREG	BATTERY FULL	95% to 65% REMAINING CAPACITY	65% to 35% REMAINING CAPACITY	35% to 5% REMAINING CAPACITY	BATTERY EMPTY
4.35 V	VBMON > 90%	VBMON = 88%	VBMON = 86%	VBMON = 84%	VBMON < 82%
4.2 V	VBMON > 98%	VBMON = 94% or 96%	VBMON = 90% or 92%	VBMON = 86% or 88%	VBMON < 84%

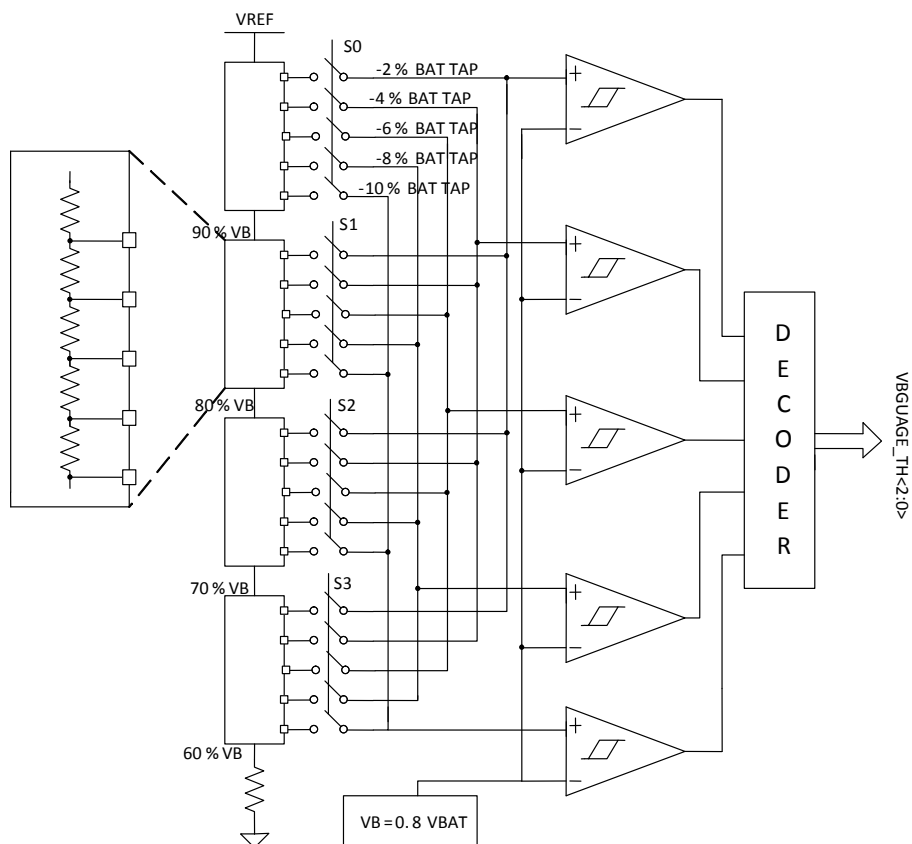

Figure 15. Voltage Battery Monitor

9.3.5 Sleep Mode

The device enters the low-power sleep mode if the voltage V_{IN} falls below the sleep-mode entry threshold and V_{IN} is higher than the undervoltage lockout threshold. In sleep mode, the input is isolated from the battery. This feature prevents draining the battery during the absence of V_{IN} . When $V_{IN} < V_{(BAT)} + V_{SLP}$, the device turns the battery discharge FET on, sends a 128- μ s pulse on the INT output, and the FAULT bits of the register are updated over I²C. Once $V_{IN} > V_{(BAT)} + V_{SLP}$, the device initiates a new charge cycle. The FAULT bits are not cleared until they are read over I²C and the sleep condition no longer exists.

9.3.6 Input Voltage Based Dynamic Power Management ($V_{IN(DPM)}$)

During the normal charging process, if the input power source is not able to support the programmed or default charging current and System load, the supply voltage decreases. Once the supply drops to $V_{IN(DPM)}$, the input DPM current and voltage loops will reduce the input current through the blocking FETs, to prevent the further drop of the supply. The $V_{IN(DPM)}$ threshold is programmable through the I²C register from 4.2 V to 4.9 V in 100-mV steps. It can be disabled completely as well. When the device enters this mode, the charge current may be lower than the set value and the VINDPM_STAT bit is set. If the 2X timer is set, the safety timer is extended while $V_{IN(DPM)}$ is active. Additionally, termination is disabled.

9.3.7 Input Overvoltage Protection and Undervoltage Status Indication

The input overvoltage protection protects the device and downstream components connected to PMID, SYS, and BAT against damage from overvoltage on the input supply. When $V_{IN} > V_{OVP}$, after the deglitch time, t_{DGL_OVP} , an OVP fault is determined to exist. During the OVP fault, the device turns the battery discharge FET on, sends a single 128- μ s pulse on INT, and the FAULT bits are updated over I²C. Once the OVP fault is removed, STAT and FAULT bits are cleared and the device returns to normal operation. The FAULT bits are not cleared until they are read in from I²C after the OVP condition no longer exists. The OVP threshold for the device is set to operate from standard USB sources.

The input under-voltage status indication is used to notify the host or other device when the input voltage falls below a desired threshold. When $V_{IN} < V_{UVLO}$, after the deglitch time t_{DGL_UVLO} , a UVLO fault is determined to exist. During the V_{IN} UVLO fault, the device sends a single 128- μ s pulse on INT, and the STAT and FAULT bits are updated over I²C. The FAULT bits are not cleared until they are read in from I²C after the UVLO condition no longer exists.

9.3.8 Battery Charging Process and Charge Profile

When a valid input source is connected ($V_{IN} > V_{UVLO}$ and $V_{(BAT)} + V_{SLP} < V_{IN} < V_{OVP}$), the \overline{CE} bit in the control register determines whether a charge cycle is initiated. When the \overline{CE} bit is 1 and a valid input source is connected, the battery discharge FET is turned off, and the output at SYS is regulated depending on the output configuration. A charge cycle is initiated when the \overline{CE} bit is written to a 0. Alternatively, the \overline{CD} input can be used to enable and disable charge.

The device supports multiple battery chemistries for single-cell applications. Charging is done through the internal battery MOSFET. There are several loops that influence the charge current: constant current loop (CC), constant voltage loop (CV), input current limit, V_{DPPM} , and $V_{IN(DPM)}$. During the charging process, all loops are enabled and the one that is dominant takes control.

The charge current is regulated to I_{CHARGE} until the voltage between BAT and GND reaches the regulation voltage. The voltage between BAT and GND is regulated to V_{BATREG} (CV Mode) while the charge current naturally tapers down. When termination is enabled, the device monitors the charging current during the CV mode, and once the charge current tapers down to the termination threshold, I_{TERM} , and the battery voltage is above the recharge threshold, the device terminates charge, and turns off the battery charging FET. Termination is disabled when any loop is active other than CV.

9.3.9 Dynamic Power Path Management Mode

With a valid input source connected, the power-path management circuitry monitors the input voltage and current continuously. The current into IN is shared at PMID between charging the battery and powering the system load at PMID, SYS, and LS/LDO. If the sum of the charging and load currents exceeds the preset maximum input current, the input DPM loop reduces input current. If PMID drops below the DPPM voltage threshold, the charging current is reduced by the DPPM loop through the BATFET. If PMID continues to drop after BATFET charging current is reduced to zero, the part enters supplement mode when PMID falls below the supplement mode threshold. Battery termination is disabled while in DPPM mode.

9.3.10 Battery Supplement Mode

While in DPPM mode, if the charging current falls to zero and the system load current increases beyond the programmed input current limit, the voltage at PMID reduces further. When the PMID voltage drops below the battery voltage by $V_{(BSUP1)}$, the battery supplements the system load. The battery stops supplementing the system load when the voltage on the PMID pin rises above the battery voltage by $V_{(BSUP2)}$. During supplement mode, the battery supplement current is not regulated, however, the short-circuit protection circuit is active. Battery termination is disabled while in supplement mode.

9.3.11 Default Mode

The default mode is used when there is no host, or I²C communication is not available. If the externally programmable pins, ILIM, ISET, and ITERM have resistors connected, that is considered the default mode. If they are tied to GND, the default register settings are used. The default mode can be entered by connecting a valid power source to V_{IN} or the RESET bit is written. Default mode is exited by writing to the I²C interface.

9.3.12 Termination and Pre-Charge Current Programming by External Components (IPRETERM)

The termination current threshold is user programmable through an external resistor or through registers over I²C. Set the termination current using the IPRETERM pin by connecting a resistor from IPRETERM to GND. The termination can be set between 5% and 20% of the programmed output current set by ISET, using [Table 3](#) for guidance:

Table 3. IPRETERM Resistor Settings

IPRE_CHARGE and ITERM			KKIPRETERM			RIPRETERM (STANDARD 1% VALUES)	UNIT
MIN	TYP (% of ISET)	MAX	MIN	TYP	MAX	RECOMMENDED RIPRETERM	
	5		180	200	220	15000	Ω
	10		180	200	220	4990	Ω
	15		180	200	220	1650	Ω
	20		180	200	220	549	Ω

Using the I²C register, the termination current can be programmed with a minimum of 500 μA and a maximum of 37 mA.

The pre-charge current is not independently programmable through the external resistor, and is set at the termination current. The pre-charge and termination currents are programmable using the I_PRETERM registers. If no IPRE_TERM resistor is connected and the pin is tied to GND, the default values in the I_PRETERM registers are used. The external value can be used in host mode by configuring the I_PRETERM registers. If the external ICHG setting will be used after being in Host mode, the I_PRETERM registers should be set to match the desired external threshold for the highest ICHG accuracy.

Termination is disabled when any loop other than CV is active.

9.3.13 Input Current Limit Programming by External Components (ILIM)

The input current limit threshold is user programmable through an external resistor or through registers over I²C. Set the input current limit using the ILIM pin by connecting a resistor from ILIM to GND using [Table 4](#) for guidance. If no ILIM resistor is connected and the pin is tied to GND, the default ILIM register value is used. The external value is not valid once the device enters host mode.

Table 4. ILIM Resistor Settings

ILIM			KILIM			RILIM (STANDARD 1% VALUES)	UNIT
MIN	TYP	MAX	MIN	TYP	MAX		
0.048469388	0.051020408	0.053571429	190	200	210	3920	Ω
0.09047619	0.095238095	0.1	190	200	210	2100	Ω
0.146153846	0.153846154	0.161538462	190	200	210	1300	Ω
0.19	0.2	0.21	190	200	210	1000	Ω
0.285714286	0.30075188	0.315789474	190	200	210	665	Ω
0.380761523	0.400801603	0.420841683	190	200	210	499	Ω

The device has register programmable input current limits from 50 mA to 400 mA in 50-mA steps. The device is USB-IF compliant for inrush current testing, assuming that the input capacitance to the device is selected to be small enough to prevent a violation (<10 μF), as this current is not limited.

9.3.14 Charge Current Programming by External Components (ISET)

The fast charge current is user programmable through an external resistor or through registers over I²C. Set the fast charge current by connecting a resistor from ISET to GND. If no ISET resistor is connected and the pin is tied to GND, the default ISET register value is used. While charging, if the charge current is using the externally programmed value, the voltage at ISET reflects the actual charging current and can be used to monitor charge current. The current out of ISET is 1/100 (±10%) of the charge current. The charge current can be calculated by using [Table 5](#) for guidance:

Table 5. ISET Resistor Settings

ISET			KISET			RISET (STANDARD 1% VALUES)	UNIT
MIN	TYP	MAX	MIN	TYP	MAX		
0.285714286	0.30075188	0.315789474	190	200	210	665	Ω
0.19	0.2	0.21	190	200	210	1000	Ω
0.126666667	0.133333333	0.14	190	200	210	1500	Ω
0.095	0.1	0.105	190	200	210	2000	Ω
0.06462585	0.068027211	0.071428571	190	200	210	2940	Ω
0.048469388	0.051020408	0.053571429	190	200	210	3920	Ω
0.038076152	0.04008016	0.042084168	190	200	210	4990	Ω
0.031456954	0.033112583	0.034768212	190	200	210	6040	Ω
0.025956284	0.027322404	0.028688525	190	200	210	7320	Ω
0.019	0.02	0.021	190	200	210	10000	Ω
0.012666667	0.013333333	0.014	190	200	210	15000	Ω
0.0095	0.01	0.0105	190	200	210	20000	Ω
0.006462585	0.006802721	0.007142857	190	200	210	29400	Ω
0.004846939	0.005102041	0.005357143	190	200	210	39200	Ω

9.3.15 Safety Timer and Watchdog Timer

At the beginning of the charge cycle, the device starts the safety timer. If charging has not terminated before the programmed safety time, t_{MAXCHG} , expires, the device enters idle mode and charging is disabled. The pre-charge safety time, t_{PRECHG} , is 10% of t_{MAXCHG} . When a safety timer fault occurs, a single 128 μs pulse is sent on the INT pin and the STAT and FAULT bits of the status registers are updated over I²C. The \overline{CD} pin or power must be toggled in order to clear the safety timer fault. The safety timer duration is programmable using the TMR bits. When the safety timer is active, changing the safety timer duration resets the safety timer. The device also contains a 2X_TIMER bit that enables the 2X timer function to prevent premature safety timer expiration when the charge current is reduced by a load on PMID, SYS, LS/LDO or a NTC condition. When t_{2X_TIMER} function is enabled, the timer is allowed to run at half speed when any loop is active other than CC or CV.

In addition to the safety timer, the device contains a 50-second watchdog timer that monitors the host through the I²C interface. Once any I²C transaction is performed on the I²C interface, a watchdog timer is started. The watchdog timer is reset by any transaction by the host using the I²C interface. If the watchdog timer expires without a reset from the I²C interface, all registers except MRRESET_VIN and MRREC are reset to the default values.

9.3.16 External NTC Monitoring (TS)

The I²C interface allows the user to easily implement the JEITA standard for systems where the battery pack thermistor is monitored by the host. Additionally, the device provides a flexible voltage based TS input for monitoring the battery pack NTC thermistor. The voltage at TS is monitored to determine that the battery is at a safe temperature during charging.

To satisfy the JEITA requirements, four temperature thresholds are monitored: the cold battery threshold, the cool battery threshold, the warm battery threshold, and the hot battery threshold. These temperatures correspond to the $V_{(COLD)}$, $V_{(COOL)}$, $V_{(WARM)}$, and $V_{(HOT)}$ threshold in the [Electrical Characteristics](#). Charging and timers are suspended when $V_{(TS)} < V_{(HOT)}$ or $> V_{(COLD)}$. When $V_{(COOL)} < V_{(TS)} < V_{(COLD)}$, the charging current is reduced to half of the programmed charge current. When $V_{(HOT)} < V_{(TS)} < V_{(WARM)}$, the battery regulation voltage is reduced by 140 mV the programmed charge current.

The TS function is voltage based for maximum flexibility. Connect a resistor divider from V_{IN} to GND with TS connected to the center tap to set the threshold. The connections are shown in [Figure 16](#). The resistor values are calculated using [Equation 1](#) and [Equation 2](#). To disable the TS function, pull TS above TS_{OFF} threshold.

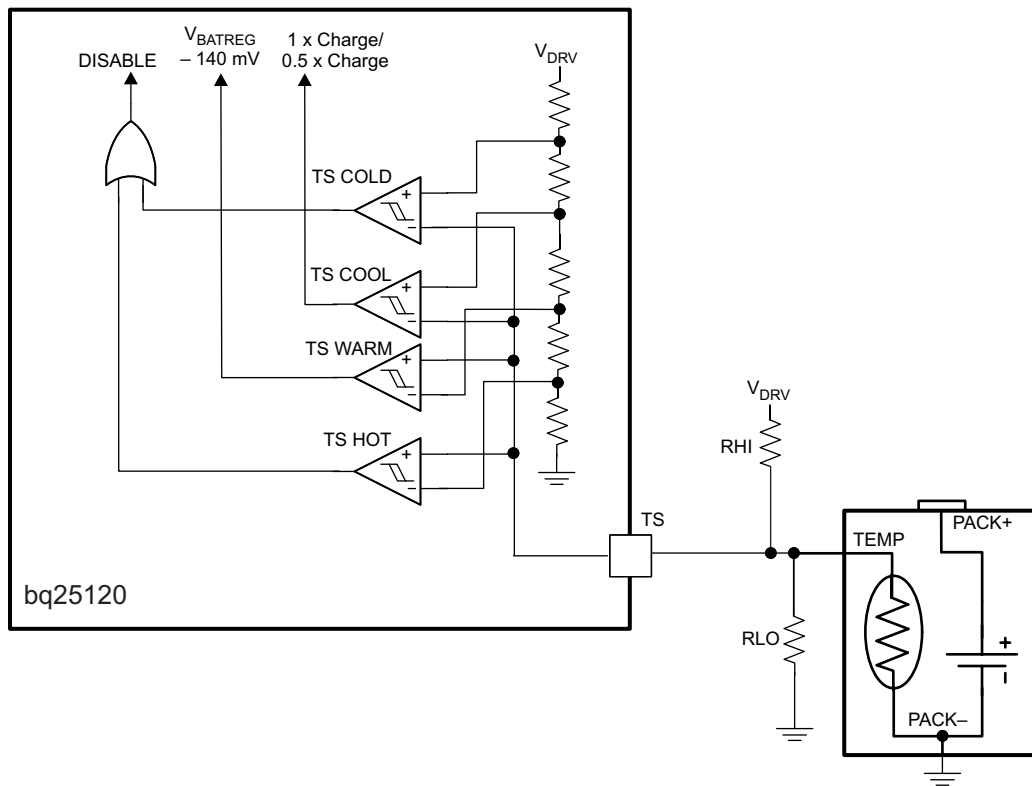

Copyright 2016, Texas Instruments Incorporated

Figure 16. TS Circuit

$$R_{(LO)} = \frac{V_{IN} \times R_{(COLD)} \times R_{(HOT)} \times \left(\frac{1}{V_{(COLD)}} - \frac{1}{V_{(HOT)}} \right)}{R_{(HOT)} \times \left(\frac{V_{IN}}{V_{(HOT)}} - 1 \right) - R_{(COLD)} \times \left(\frac{V_{IN}}{V_{(COLD)}} - 1 \right)} \quad (1)$$

$$R_{(HI)} = \frac{\left(\frac{V_{IN}}{V_{(COLD)}} - 1 \right)}{\left(\frac{1}{R_{(LO)}} + \frac{1}{R_{(COLD)}} \right)} \quad (2)$$

Where

- $R_{(HOT)}$ = the NTC resistance at the hot temperature
- $R_{(COLD)}$ = the NTC resistance at the cold temperature

The warm and cool thresholds are not independently programmable. The cool and warm NTC resistances for a selected resistor divider are calculated using [Equation 3](#) and [Equation 4](#).

$$R_{(COOL)} = \frac{R_{(LO)} \times R_{(HI)} \times 0.57}{R_{(LO)} - R_{(LO)} \times 0.57 - R_{(HI)} \times 0.57} \quad (3)$$

$$R_{(WARM)} = \frac{R_{(LO)} \times R_{(HI)} \times 0.38}{R_{(LO)}} - (R_{(LO)} \times 0.38 - R_{(HI)} \times 0.38) \quad (4)$$

9.3.17 Thermal Protection

During the charging process, to prevent overheating in the device, the junction temperature of the die, T_J , is monitored. When T_J reaches $T_{(SHUTDOWN)}$ the device stops charging, disables the PMID output, SYS output, and disables the LS/LDO output. During the time that $T_{(SHUTDOWN)}$ is exceeded, the safety timer is reset and the watchdog timer continues to operate if in host mode. The charge cycle resumes when T_J falls below $T_{(SHUTDOWN)}$ by $T_{(HYS)}$.

To avoid reaching thermal shutdown, ensure that the system power dissipation is under the limits of the device. The power dissipated by the device can be calculated using [Equation 5](#).

$$P_{DISS} = P_{(LS/LDO)} + P_{(SYS)} + P_{(LS/LDO)} + P_{(BAT)} \quad (5)$$

Where

- $P_{(LS/LDO)} = (V_{IN} - V_{(LS/LDO)}) \times I_{IN}$
- $P_{(SYS)} = (V_{IN} - V_{(LS/LDO)}) \times I_{IN}$
- $P_{(LS/LDO)} = (V_{(INLS)} - V_{(LS/LDO)}) \times I_{(LS/LDO)}$
- $P_{(BAT)} = (V_{(PMID)} - V_{(BAT)}) \times I_{(BAT)}$

9.3.18 Typical Application Power Dissipation

The die junction temperature, T_J , can be estimated based on the expected board performance using [Equation 6](#).

$$T_J = T_A + \theta_{JA} \times P_{DISS} \quad (6)$$

The θ_{JA} is largely driven by the board layout. For more information about traditional and new thermal metrics, see the IC Package Thermal Metrics application report [SPRA953](#). Under typical conditions, the time spent in this state is short.

9.3.19 Status Indicators (\overline{PG} and INT)

The device contains two open-drain outputs that signal its status and are valid only after the device has completed start-up into a valid state. If the part starts into a fault, interrupts will not be sent. The \overline{PG} output signals when a valid input source is connected. \overline{PG} pulls to GND when V_{IN} is above V_{UVLO} . \overline{PG} is high-impedance when the input power is not within specified limits. Connect \overline{PG} to the desired logic voltage rail using a 1-k Ω to 100-k Ω resistor, or use with an LED for visual indication.

The \overline{PG} pin can be configured as a \overline{MR} shifted (MRS) output when the $\overline{PGB_MRS}$ bit is set to 1. \overline{PG} is high-impedance when the \overline{MR} input is not low, and \overline{PG} pulls to GND when the \overline{MR} input is below $V_{OL(TH_MRS)}$. Connect \overline{PG} to the desired logic voltage rail using a 1-k Ω to 100-k Ω resistor.

When enabled through OTP, the \overline{PG} pin also functions as an OVP/UVI indicator. When the device is below V_{SLP} or $V_{IN(DPM)}$ (if enabled), a single 128 μ s pulse is sent on \overline{PG} to notify the host, repeating once per minute. When the device has an input voltage greater than $V_{(BAT)} + 1$ V and V_{IN} is less than V_{OVP} , two consecutive 128 μ s pulses are sent on \overline{PG} , to notify the host, repeating once per minute. The \overline{PG} pin does not function as an input power good indicator in this mode.

The INT pin is pulled low during charging when the EN_INT bit is set to 1. When EN_INT is set to 0, charging status is not indicated on the INT pin. When charge is complete or disabled, INT is high impedance. The charge status is valid whether it is the first charge or recharge. When a fault occurs, a 128 μ s pulse (interrupt) is sent on INT to notify the host.

9.3.20 Chip Disable (\overline{CD})

The device contains a \overline{CD} input that is used to disable the device and place it into a high impedance mode when only battery is present. In this case, when \overline{CD} is low, PMID and SYS remain active, and the battery discharge FET is turned on. If the LS/LDO output has been enabled prior to pulling \overline{CD} low, it will stay on. The LSCTRL pin can also enable/disable the LS/LDO output when the \overline{CD} pin is pulled low. The \overline{CD} pin has an internal pull-down.

If V_{IN} is present and the \overline{CD} input is pulled low, charge is enabled and all other functions remain active. If V_{IN} is present and the \overline{CD} input is pulled high, charge is disabled.

9.3.21 Buck (PWM) Output

The device integrates a low quiescent current switching regulator with DCS control allowing high efficiency down to 10- μ A load currents. DCS control combines the advantages of hysteretic and voltage mode control. The internally compensated regulation network achieves fast and stable operation with small external components and low ESR capacitors. During PWM mode, it operates in continuous conduction mode, with a frequency up to 3 MHz. If the load current decreases, the converter enters a power save mode to maintain high efficiency down to light loads. In this mode, the device generates a single switching pulse to ramp up the inductor current and recharge the output capacitor, followed by a sleep period where most of the internal circuits are shut down to achieve a low quiescent current. The duration of the sleep period depends on the load current and the inductor peak current.

The output voltage is programmable using the SYS_SEL and SYS_VOUT bits in the SYS VOUT control register.

The SW output is enabled using the EN_SYS_OUT bit in the register. When the device is enabled, the internal reference is powered up and the device enters softstart, starts switching, and ramps up the output voltage. When SW is disabled, the output is in shutdown mode in a low quiescent state. The device provides automatic output voltage discharge so the output voltage will ramp up from zero once the device is enabled again. Once SYS has been disabled, either V_{IN} needs to be connected or the MR button must be held low for the t_{RESET} duration to re-enable SYS.

The output is optimized for operation with a 2.2- μ H inductor and 10- μ F output capacitor. The recommended LC output filter combinations are:

INDUCTOR VALUE (μ H)	OUTPUT CAPACITOR VALUE (μ F)		
	4.7	10	22
2.2	Possible	Recommended	Possible

The inductor value affects the peak-to-peak ripple current, the PWM-to-PFM transition point where the part enters and exits Pulse Frequency Modulation to lower the power consumed at low loads, the output voltage ripple and the efficiency. The selected inductor has to be rated for its DC resistance and saturation current. The inductor ripple current (ΔI_L) decreases with higher inductance and increases with higher V_{IN} or V_{OUT} and can be estimated according to [Equation 7](#).

$$\Delta I_L = V_{OUT} \times (1 - (V_{OUT}/V_{IN})) / (L \times f) \quad (7)$$

Use [Equation 8](#) to calculate the maximum inductor current under static load conditions. The saturation current of the inductor should be rated higher than the maximum inductor current. As the size of the inductor decreases, the saturation “knee” must be carefully considered to ensure that the inductance does not decrease during higher load condition or transient. This is recommended because during a heavy load transient the inductor current rises above the calculated value. A more conservative way is to select the inductor saturation current above the high-side MOSFET switch current.

$$I_L(\max) = I_{OUT}(\max) + \Delta I_L / 2 \quad (8)$$

Where

- F = Switching Frequency
- L = Inductor Value
- ΔI_L = Peak to Peak inductor ripple current
- $I_L(\max)$ = Maximum Inductor current

In DC/DC converter applications, the efficiency is affected by the inductor AC resistance and by the inductor DCR value. Increasing the inductor fault produces lower RMS currents, but degrades transient response.

The following inductor series from different suppliers are recommended:

Table 6. Inductor Series

INDUCTANCE (μ H)	DCR (Ω)	DIMENSIONS (mm^3)	INDUCTOR TYPE	SUPPLIER ⁽¹⁾	COMMENT
2.2	0.300	1.6 x 0.8 x 0.8	MDT1608CH2R2N	TOKO	Smallest size, 75mA max
2.2	0.170	1.6 x 0.8 x 0.8	GLFR1608T2R2M	TDK	Smallest size, 150mA max
2.2	0.245	2.0 x 1.2 x 1.0	MDT2012CH2R2N	TOKO	Small size, high efficiency

(1) See [Third-party Products Disclaimer](#)

Table 6. Inductor Series (continued)

INDUCTANCE (μH)	DCR (Ω)	DIMENSIONS (mm ³)	INDUCTOR TYPE	SUPPLIER ⁽¹⁾	COMMENT
2.2	0.23	2.0 x 1.2 x 1.0	MIPSZ2012 2R2	TDK	
2.2	0.225	2.0 x 1.6 x 1.0	74438343022	Würth	
2.2	0.12	2.5 x 2.0 x 1.2	MIPSA2520 2R2	TDK	
2.2	0.145	3.3 x 3.3 x 1.4	LPS3314	Coicraft	

The PWM allows the use of small ceramic capacitors. Ceramic capacitors with low ESR values have the lowest output voltage ripple and are recommended. The output capacitor requires either an X7R or X5R dielectric. At light load currents, the converter operates in Power Save Mode and the output voltage ripple is dependent on the output capacitor value and the PFM peak inductor current. Because the PWM converter has a pulsating input current, a low ESR input capacitor is required on PMID for the best voltage filtering to ensure proper function of the device and to minimize input voltage spikes. For most applications a 10-μF capacitor value is sufficient. The PMID capacitor can be increased to 22 μF for better input voltage filtering.

The following input/output capacitors are recommended:

Table 7. Capacitors

CAPACITANCE (μF)	SIZE	CAPACITOR TYPE	SUPPLIER ⁽¹⁾	COMMENT
10	0603	GRM188R60J106ME84	Murata	Recommended
10	0402	CL05A106MP5NUNC	Samsung EMA	Smallest size (TO BE TESTED)

(1) See [Third-party Products Disclaimer](#)

9.3.22 Load Switch / LDO Output and Control

The device integrates a low I_q load switch which can also be used as a regulated output. The LSCTRL pin can be used to turn the load on or off. Activating LSCTRL continuously holds the switch in the on state so long as there is not a fault. The signal is active HI and has a low threshold making it capable of interfacing with low voltage signals. To limit voltage drop or voltage transients, a small ceramic capacitor must be placed close to VINLS. Due to the body diode of the PMOS switch, it is recommended to have the capacitor on VINLS ten times larger than the output capacitor on LS/LDO.

The output voltage is programmable using the LS_LDO bits in the register. The LS/LDO voltage is calculated using [Equation 9](#).

$$LS/LDO = 0.8 \text{ V} + LS_LDOCODE \times 100 \text{ mV} \quad (9)$$

If a value greater than 3.3 V is written, the setting goes to pass-through mode where LS/LDO = VINLS - V_(DROPOUT). [Table 8](#) summarizes the control of the LS/LDO output based on the I²C or LSCTRL pin setting:

Table 8. LS/LDO Output Control

I ² C LS_LDO_EN	PIN LSCTRL	I ² C V _{LDO} > 3.3	LS/LDO Output
0	0	0	Pulldown
0	0	1	Pulldown
0	1	0	V _{LDO}
0	1	1	LSW
1	0	0	V _{LDO}
1	0	1	LSW
1	1	0	V _{LDO}
1	1	1	LSW

If the output of the LDO is less than the programmed V_(SYS) voltage, connect VINLS to SYS. If the output of the LDO is greater than the programmed V_(SYS) voltage, connect VINLS to PMID.

The current capability of the LDO depends on the VINLS input voltage and the programmed output voltage. The full 100-mA output current for 0.8-V output voltage can be achieved when V_(VINLS) > 3.25 V. The full 100-mA output current for 3.3-V output voltage can be achieved when V_(VINLS) > 3.6 V.

When the LSLDO output is disabled with LSCTRL or through the register, an internal pull-down will discharge the output.

9.3.23 Manual Reset Timer and Reset Output ($\overline{\text{MR}}$ and $\overline{\text{RESET}}$)

The $\overline{\text{MR}}$ input has an internal pull-up to BAT, and $\overline{\text{MR}}$ is functional only when BAT is present or VIN is valid and charge is enabled. The input conditions can be adjusted by using MRWAKE bits for the wake conditions and MRRESET bits for the reset conditions. When a wake condition is met, a 128- μs pulse is sent on INT to notify the host, and the WAKE1 and/or WAKE2 bits are updated on I²C. The MR_WAKE bits and RESET FAULT bits are not cleared until the Push-button Control Register is read from I²C.

When a $\overline{\text{MR}}$ reset condition is met, a 128 μs pulse is sent on INT to notify the host and a $\overline{\text{RESET}}$ signal is asserted. A reset pulse occurs with duration of $t_{\text{RESET_D}}$ only one time after each valid MRRESET condition. The $\overline{\text{MR}}$ pin must be released (go high) and then driven low for the MRWAKE period before $\overline{\text{RESET}}$ asserts again. After $\overline{\text{RESET}}$ is asserted with battery only present, the device enters either Ship mode or Hi-Z mode depending on MRREC register settings. After $\overline{\text{RESET}}$ is asserted with a valid V_{IN} present, the device resumes operation prior to the MR button press. If SYS was disabled prior to $\overline{\text{RESET}}$, the SYS output is re-enabled if recovering into Hi-Z or Idle.

The MRRESET_VIN register can be configured to have $\overline{\text{RESET}}$ asserted by a button press only, or by a button press and V_{IN} present ($V_{\text{UVLO}} + V_{\text{SLP}} < V_{\text{IN}} < V_{\text{OVP}}$).

9.4 Device Functional Modes

Table 9. Modes and Functions

FUNCTION	READY (PRIOR TO I ² C) AND AFTER RESET	HOST MODE READY (AFTER I ² C)	CHARGE	SHIP MODE	HIGH_Z	ACTIVE BATTERY
VOVP	Yes	Yes	Yes	No	No	No
VUVLO	Yes	Yes	Yes	Yes	Yes	Yes
VBATUVLO	Yes	Yes	Yes	No	Yes	Yes
VINDPM	OTP or registers	OTP or registers	If enabled	No	No	No
SYS	OTP or registers	OTP or registers	If enabled	No	If enabled	If enabled
LS/LDO	OTP or registers	OTP or registers	If enabled	No	If enabled	If enabled
BATFET	Yes	Yes	Yes	No	Yes	Yes
TS	Yes	Yes	Yes	No	No	No
IPRETERM	External	OTP, registers, or external	OTP, registers, or external	No	No	No
ISET	External	OTP, registers, or external	OTP, registers, or external	No	No	No
ILIM	External	OTP, registers, or external	OTP, registers, or external	No	No	No
$\overline{\text{MR}}$ input	Yes	Yes	Yes	Yes	Yes	Yes
LSCTRL input	Yes	Yes	Yes	No	Yes	Yes
RESET output	Yes	Yes	Yes	No	Yes	Yes
INT output	Yes	Yes	Yes	No	No	Yes
I ² C interface	Yes	Yes	Yes	No	No	Yes
$\overline{\text{CD}}$ input	Yes	Yes	Yes	No	Yes	Yes
$\overline{\text{PG}}$ output	Yes	Yes	Yes	No	No	If enabled
VBMON	No	Yes	No	No	No	Yes

Table 10. Fault and Status Condition Responses

FAULT or STATUS	ACTIONS	CHARGER BEHAVIOR	SYS BEHAVIOR	LS/LDO BEHAVIOR	TS BEHAVIOR
VIN_OV	Update VIN_OV status, Update STAT to fault, interrupt on INT, PG shown not good	Disabled	Enabled through BAT	Enabled through BAT	Disabled
VIN_UV	Update VIN_UV status, Update STAT to fault, interrupt on INT, PG shown not good	Disabled	Enabled through BAT	Enabled through BAT	Disabled
VIN_ILIM	Update VIN_ILIM status, charge in progress status, interrupt on INT, input current is limited	Enabled, input current limited	Enabled (if enabled)	Enabled (if enabled)	Enabled
OVER_TEMP	Update OVER_TEMP status (die temp), fault status, interrupt on INT	Disabled	Disabled	Disabled	Disabled
BAT_UVLO	Update BAT_UVLO status, Update STAT to fault, interrupt on INT	Pre-charge	Enabled (if enabled) and VIN Valid	Enabled (if enabled) and VIN Valid	Enabled if VIN Valid
SW_SYS_SHORT	Update SW_SYS_SHORT, Update STAT to fault, interrupt on INT	Enabled	Current Limit	Enabled (if enabled)	Enabled
LS_LDO_OCP	Update LS_LDO_OCP, Update STAT to fault, interrupt on INT	Enabled	Enabled (if enabled)	Current Limit	Enabled
TIMER fault	Update TIMER, Update STAT to fault, interrupt on INT	Disabled	Enabled (if enabled)	Enabled (if enabled)	Disabled
VINDPM	Update VINDPM_STAT, Update STAT to fault, interrupt on INT	Enabled, input current reduced	Enabled (if enabled)	Enabled (if enabled)	Enabled
TS_FAULT COLD or HOT	Update TS_FAULT to COLD OR HOT, Update STAT to fault, interrupt on INT	Disabled	Enabled (if enabled)	Enabled (if enabled)	Enabled
TS_FAULT COOL	Update TS_FAULT to COOL, Update STAT to fault, interrupt on INT	Reduce ICHG to ½	Enabled (if enabled)	Enabled (if enabled)	Enabled
TS_FAULT WARM	Update TS_FAULT to WARM, Update STAT to fault, interrupt on INT	Reduce VBATREG by 140 mV	Enabled (if enabled)	Enabled (if enabled)	Enabled
Charge Done	Update STAT to Charge Done, interrupt on INT	Disabled, monitor for VBAT falling below VRCHG	Enabled (if enabled)	Enabled (if enabled)	Enabled

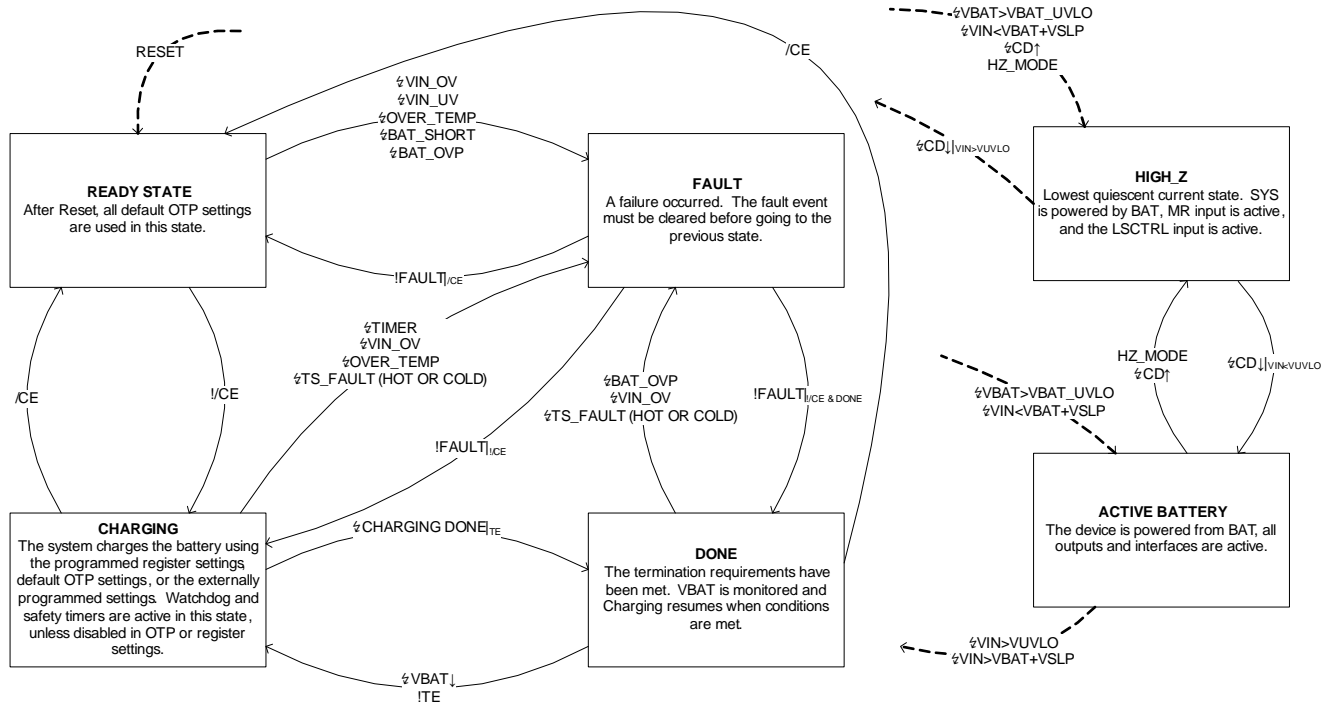

Comments about naming convention

"/CE" or "HZ_MODE" -> Register name: event caused by user / configuration

"!" -> Not

"<" -> Event caused by external influence

"Event|condition" -> describes the event with a specific condition

Figure 17. State Diagram

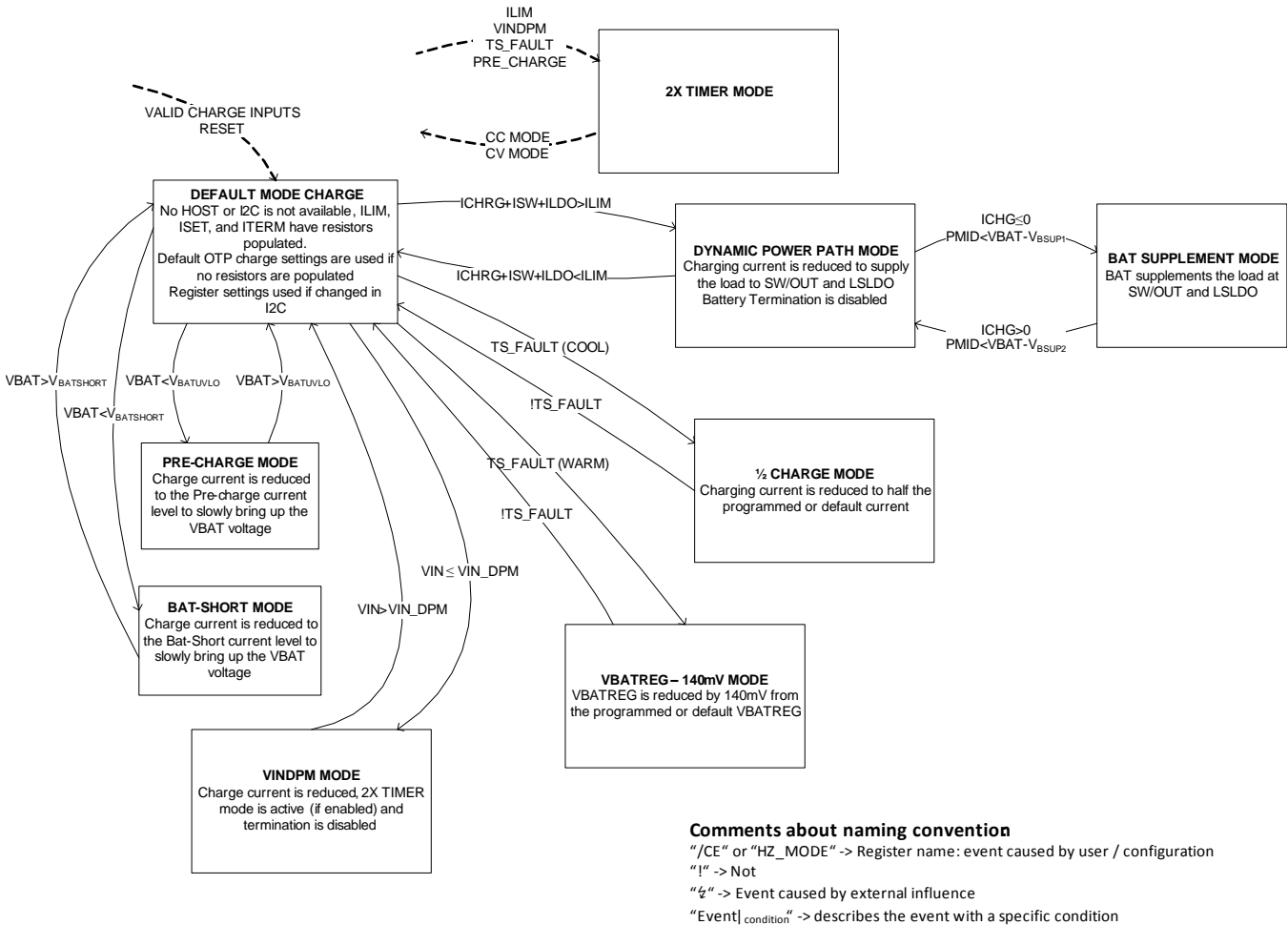

Figure 18. Change State Diagram

9.5 Programming

9.5.1 Serial Interface Description

The device uses an I²C compatible interface to program and read many parameters. I²C is a 2-wire serial interface developed by NXP. The bus consists of a data line (SDA) and a clock line (SCL) with pull-up structures. When the bus is idle, both SDA and SCL lines are pulled high. All the I²C compatible devices connect to the I²C bus through open drain I/O terminals, SDA and SCL. A master device, usually a microcontroller or digital signal processor, controls the bus. The master is responsible for generating the SCL signal and device addresses. The master also generates specific conditions that indicate the START and STOP of data transfer. A slave device receives and/or transmits data on the bus under control of the master device.

The device works as a slave and supports the following data transfer modes, as defined in the I²C BUS Specification: standard mode (100 kbps) and fast mode (400kbps). The interface adds flexibility to the battery management solution, enabling most functions to be programmed to new values depending on the instantaneous application requirements. The I²C circuitry is powered from the battery in active battery mode. The battery voltage must stay above V_(BATUVLO) when no V_{IN} is present to maintain proper operation.

The data transfer protocol for standard and fast modes is exactly the same; therefore, they are referred to as the F/S-mode in this document. The device only supports 7-bit addressing. The device 7-bit address is 6A (8-bit shifted address is D4).

Programming (continued)

To avoid I²C hang-ups, a timer ($t_{I2C\text{RESET}}$) runs during I²C transactions. If the SDA line is held low longer than $t_{I2C\text{RESET}}$, any additional commands are ignored and the I²C engine is reset. The timeout is reset with START and repeated START conditions and stops when a valid STOP condition is sent.

9.5.2 F/S Mode Protocol

The master initiates data transfer by generating a start condition. The start condition is when a high-to-low transition occurs on the SDA line while SCL is high, as shown in Figure 19. All I²C-compatible devices should recognize a start condition.

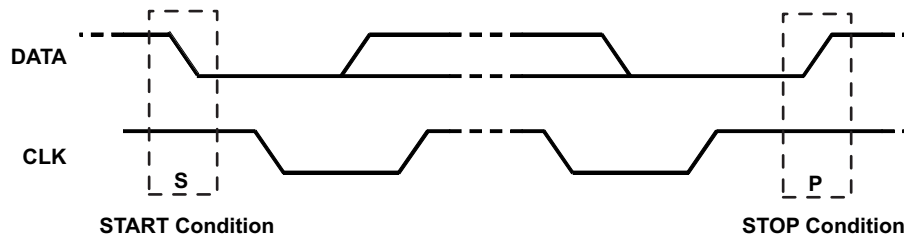

Figure 19. Start Stop Condition

The master then generates the SCL pulses, and transmits the address and the read/write direction bit R/W on the SDA line. During all transmissions, the master ensures that data is valid. A valid data condition requires the SDA line to be stable during the entire high period of the clock pulse (see Figure 20). All devices recognize the address sent by the master and compare it to their internal fixed addresses. Only the slave device with a matching address generates and acknowledge (see Figure 21) by pulling the SDA line low during the entire high period of the ninth SCL cycle. Upon detecting the acknowledge, the master knows that communication link with a slave has been established.

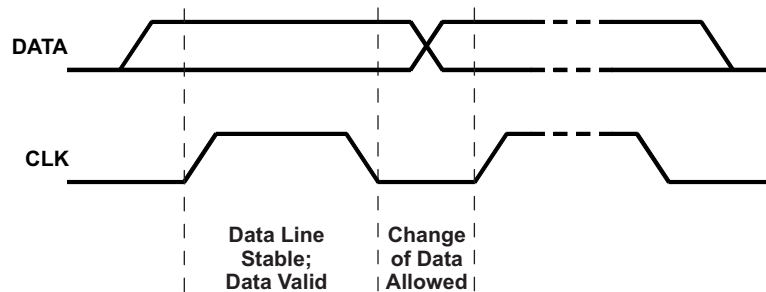

Figure 20. Bit Transfer on the Serial Interface

Programming (continued)

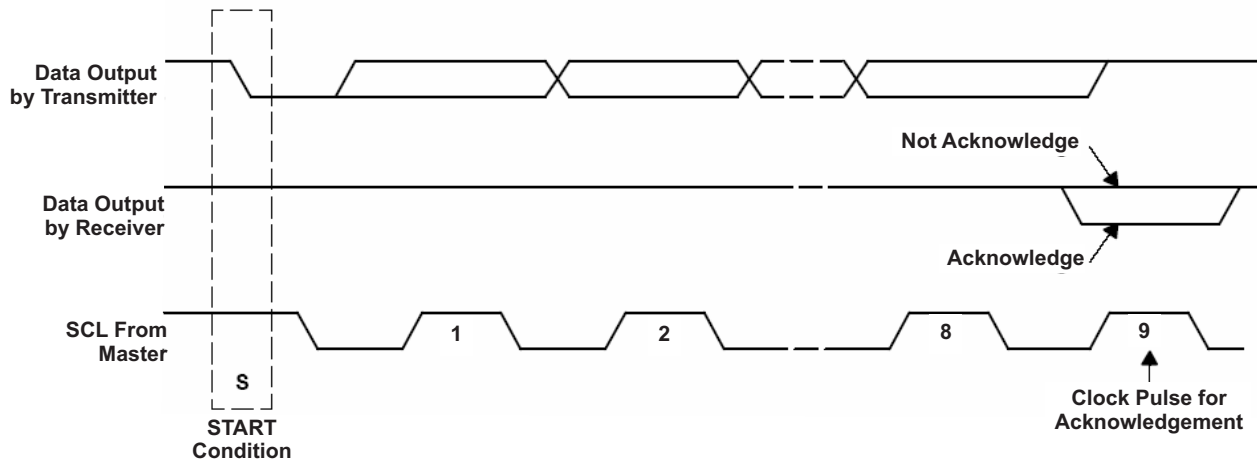

Figure 21. Acknowledge on the I²C Bus

The master generates further SCL cycles to either transmit data to the slave (R/W bit 0) or receive data from the slave (R/W bit 1). In either case, the receiver needs to acknowledge the data sent by the transmitter. An acknowledge signal can either be generated by the master or by the slave, depending on which one is the receiver. The 9-bit valid data sequences consisting of 8-bit data and 1-bit acknowledge can continue as long as necessary. To signal the end of the data transfer, the master generates a stop condition by pulling the SDA line from low to high while the SCL line is high (see Figure 22). This releases the bus and stops the communication link with the addressed slave. All I²C compatible devices must recognize the STOP condition. Upon the receipt of a STOP condition, all devices know that the bus is released, and wait for a START condition followed by a matching address. If a transaction is terminated prematurely, the master needs to send a STOP condition to prevent the slave I²C logic from remaining in an incorrect state. Attempting to read data from register addresses not listed in this section results in 0xFFh being read out.

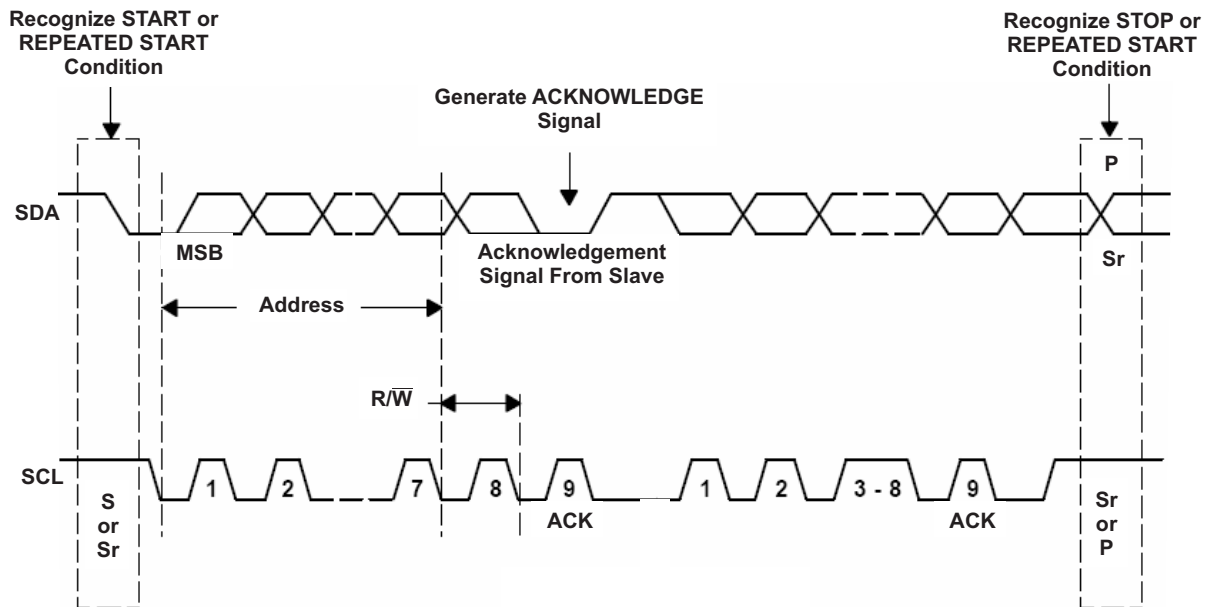

Figure 22. Bus Protocol

9.6 Register Maps

9.6.1 Status and Ship Mode Control Register

Memory location 0x00h, Reset State: xx0x xxx1 (bq25120)

Figure 23. Status and Ship Mode Control Register

7 (MSB)	6	5	4	3	2	1	0 (LSB)
x	x	0	x	x	x	x	1
R	R	Write Only	R	R	R	R	R

LEGEND: R/W = Read/Write; R = Read only; -n = value after reset

Table 11. Status and Ship Mode Control Register

Bit	Field	Type	Reset	Description
B7 (MSB)	STAT_1	R	x	00 - Ready 01 - Charge in Progress 10 - Charge done 11 - Fault Status is current status only.
B6	STAT_0	R	x	
B5	EN_SHIPMODE	Write Only	0	0 – Normal BAT ONLY Operation 1 – Ship Mode Enabled
B4	RESET_FAULT	R	x	1 – RESET fault. Indicates when the device meets the RESET conditions, and is cleared after I ² C read.
B3	TIMER	R	x	1 – Safety timer fault. Continues to show fault after an I ² C read unless the \overline{CD} pin or power have been toggled.
B2	VINDPM_STAT	R	x	0 – VIN_DPM is not active 1 – VIN_DPM is active
B1	\overline{CD} _STAT	R	x	0 – \overline{CD} low, IC enabled 1 – \overline{CD} high, IC disabled
B0 (LSB)	SYS_EN_STAT	R	x	1 – SW enabled 0 – SW disabled

9.6.2 Faults and Faults Mask Register

Memory location 0x01h, Reset State: xxxx 0000 (bq25120)

Figure 24. Faults and Faults Mask Register

7 (MSB)	6	5	4	3	2	1	0 (LSB)
x	x	x	x	0	0	0	0
R	R	R	R	R/W	R/W	R/W	R/W

LEGEND: R/W = Read/Write; R = Read only; -n = value after reset

Table 12. Faults and Faults Mask Register

Bit	Field	Type	Reset	Description
B7 (MSB)	VIN_OV	R	x	1 - V_{IN} overvoltage fault. VIN_OV continues to show fault after an I ² C read as long as OV exists
B6	VIN_UV	R	x	1 - V_{IN} undervoltage fault. VIN_UV is set when the input falls below V_{SLP} . VIN_UV fault shows only one time. Once read, VIN_UV clears until the the UVLO event occurs.
B5	BAT_UVLO	R	x	1 – BAT_UVLO fault. BAT_UVLO continues to show fault after an I ² C read as long as BAT_UVLO conditions exist.
B4	BAT_OCP	R	x	1 – BAT_OCP fault. BAT_OCP is cleared after I ² C read.
B3	VIN_OV_M	R/W	0	1 – Mask V_{IN} overvoltage fault
B2	VIN_UV_M	R/W	0	1 – Mask V_{IN} undervoltage fault
B1	BAT_UVLO_M	R/W	0	1 – Mask BAT UVLO fault
B0 (LSB)	BAT_OCP_M	R/W	0	1 – Mask BAT_OCP fault

9.6.3 TS Control and Faults Masks Register

Memory location 0x02h, Reset State: 1xxx 1000 (bq25120)

Figure 25. TS Control and Faults Masks Register (02)

7 (MSB)	6	5	4	3	2	1	0 (LSB)
1	x	x	x	1	0	0	0
R/W	R	R	R	R/W	R/W	R/W	R/W

LEGEND: R/W = Read/Write; R = Read only; -n = value after reset

Table 13. TS Control and Faults Masks Register, Memory Location 0010

Bit	Field	Type	Reset	Description
B7 (MSB)	TS_EN	R/W	1	0 – TS function disabled 1 – TS function enabled
B6	TS_FAULT1	R	x	TS Fault mode: 00 – Normal, No TS fault 01 – TS temp < T _{COLD} or TS temp > T _{HOT} (Charging suspended) 10 – T _{COOL} > TS temp > T _{COLD} (Charging current reduced by half) 11 – T _{WARM} < TS temp < T _{HOT} (Charging voltage reduced by 140 mV)
B5	TS_FAULT0	R	x	
B4	TS_FAULT_OPEN	R	x	0 – No TS OFF fault 1 – TS OFF fault indicated, and charge has stopped (if enabled in OTP_EN_TS_OPEN)
B3	EN_INT	R/W	1	0 – Disable INT function (INT only shows faults) 1 – Enable INT function
B2	WAKE_M	R/W	0	1 – Mask Wake Condition from \overline{MR}
B1	RESET_M	R/W	0	1 – Mask RESET condition from \overline{MR}
B0 (LSB)	TIMER_M	R/W	0	1 – Mask Timer fault (safety)

9.6.4 Fast Charge Control Register

Memory location 0x03h, Reset State: 0001 0100 (bq25120), 0000 1100 (SN2500)

Figure 26. Fast Charge Control Register

7 (MSB)	6	5	4	3	2	1	0 (LSB)
0	0	0	1	0	1	0	0
R/W	R/W	R/W	R/W	R/W	R/W	R/W	R/W

LEGEND: R/W = Read/Write; R = Read only; -n = value after reset

Table 14. Fast Charge Control Register

Bit	Field	Type	Reset	Description
B7 (MSB)	ICHRG_RANGE	R/W	0	0 – to select charge range from 5 mA to 35 mA, ICHRG bits are 1-mA steps 1 – to select charge range from 40 mA to 300 mA, ICHRG bits are 10-mA steps
B6	ICHRG_4	R/W	0	Charge current 16 mA or 160 mA
B5	ICHRG_3	R/W	0	Charge current 8 mA or 80 mA
B4	ICHRG_2	R/W	1	Charge current 4 mA or 40 mA
B3	ICHRG_1	R/W	0	Charge current 2 mA or 20 mA
B2	ICHRG_0	R/W	1	Charge current 1 mA or 10 mA
B1	$\overline{\text{CE}}$	R/W	0	0 – Charger enabled 1 – Charger is disabled
B0 (LSB)	HZ_MODE	R/W	0	0 – Not high impedance mode 1 – High impedance mode

ICHRG_RANGE and ICHRG bits are used to set the charge current. The I_{CHRG} is calculated using the following equation: If ICHRG_RANGE is 0, then $I_{\text{CHRG}} = 5 \text{ mA} + I_{\text{CHRG}}\text{CODE} \times 1 \text{ mA}$. If ICHRG_RANGE is 1, then $I_{\text{CHRG}} = 40 \text{ mA} + I_{\text{CHRG}}\text{CODE} \times 10 \text{ mA}$. If a value greater than 35 mA (ICHRG_RANGE = 0) or 300 mA (ICHRG_RANGE = 1) is written, the setting goes to 35 mA or 300 mA respectively except if the ICHRG bits are all 1 (that is, 11111), then the externally programmed value is used. The default is programmed by OTP. The default is programmed by the external resistor on ISET, or if not populated and tied to GND, by OTP.

9.6.5 Termination/Pre-Charge and I²C Address Register

Memory location 0x04h, Reset State: 0000 1110 (bq25120)

Figure 27. Termination/Pre-Charge and I²C Address Register

7 (MSB)	6	5	4	3	2	1	0 (LSB)
0	0	0	0	1	1	1	0
R/W	R/W	R/W	R/W	R/W	R/W	R/W	R/W

LEGEND: R/W = Read/Write; R = Read only; -n = value after reset

Table 15. Termination/Pre-Charge and I²C Address Register

Bit	Field	Type	Reset	Description
B7 (MSB)	IPRETERM_RANGE	R/W	0	0 – to select termination range from 500 μ A to 5 mA, IPRETERM bits are 500- μ A steps 1 – to select charge range from 6 mA to 37 mA, IPRETERM bits are 1-mA steps
B6	IPRETERM_4	R/W	0	Termination current 8 mA or 16 mA
B5	IPRETERM_3	R/W	0	Termination current 4 mA or 8 mA
B4	IPRETERM_2	R/W	0	Termination current 2 mA or 4 mA
B3	IPRETERM_1	R/W	1	Termination current 1 mA or 2 mA
B2	IPRETERM_0	R/W	1	Termination current 500 μ A or 1 mA
B1	TE	R/W	1	0 – Disable charge current termination 1 – Enable charge current termination
B0 (LSB)		R/W	0	

IPRETERM_RANGE and IPRETERM bits are used to set the termination and pre-charge current. The I_{TERM} is calculated using the following equation: If IPRETERM_RANGE is 0, then $I_{TERM} = 500 \mu A + I_{TERM}CODE \times 500 \mu A$. If IPRETERM_RANGE is 1, then $I_{TERM} = 6 \text{ mA} + I_{TERM}CODE \times 1 \text{ mA}$. If a value greater than 5 mA (IPRETERM_RANGE = 0) is written, the setting goes to 5 mA. Termination is disabled if any loop other than CC or DV in control, such as VINDPM, and TS/Cool. The default is programmed by the external resistor on IPRETERM, or if not populated and tied to GND, by OTP.

9.6.6 Battery Voltage Control Register

Memory location 0x05h, Reset State: 0111 1000 (bq25120)

Figure 28. Battery Voltage Control Register

7 (MSB)	6	5	4	3	2	1	0 (LSB)
0	1	1	1	1	0	0	0
R/W	R/W	R/W	R/W	R/W	R/W	R/W	R/W

LEGEND: R/W = Read/Write; R = Read only; -n = value after reset

Table 16. Battery Voltage Control Register

Bit	Field	Type	Reset	Description
B7 (MSB)	VBREG_6	R/W	0	Battery Regulation Voltage: 640 mV
B6	VBREG_5	R/W	1	Battery Regulation Voltage: 320 mV
B5	VBREG_4	R/W	1	Battery Regulation Voltage: 160 mV
B4	VBREG_3	R/W	1	Battery Regulation Voltage: 80 mV
B3	VBREG_2	R/W	1	Battery Regulation Voltage: 40 mV
B2	VBREG_1	R/W	0	Battery Regulation Voltage: 20 mV
B1	VBREG_0	R/W	0	Battery Regulation Voltage: 10 mV
B0 (LSB)		R/W	0	

VBREG Bits: Use VBREG bits to set the battery regulation threshold. The V_{BATREG} is calculated using the following equation: $V_{BATREG} = 3.6 \text{ V} + V_{BREG}CODE \times 10 \text{ mV}$. The charge voltage range is from 3.6 V to 4.65 V. If a value greater than 4.65 V is written, the setting goes to 4.65 V. Default is programmed by OTP.

9.6.7 SYS VOUT Control Register

Memory location 0x06h, Reset State: 1010 1010 (bq25120)

Figure 29. SYS VOUT Control Register

7 (MSB)	6	5	4	3	2	1	0 (LSB)
1	0	1	0	1	0	1	0
R/W	R/W	R/W	R/W	R/W	R/W	R/W	R/W

LEGEND: R/W = Read/Write; R = Read only; -n = value after reset

Table 17. SYS VOUT Control Register

Bit	Field	Type	Reset	Description
B7 (MSB)	EN_SYS_OUT	R/W	1	0 – Disable SW 1 – Enable SW (When disabled, output is pulled low)
B6	SYS_SEL1	R/W	0	00 – 1.1 V and 1.2 V selection
B5	SYS_SEL0	R/W	1	01 – 1.3 V through 2.8 V selection, 10 – Not Valid 11 – 1.8 V through 3.3 V selection
B4	SYS_VOUT_3	R/W	0	OUT Voltage: 800 mV step if SYS_SEL is 01 or 11
B3	SYS_VOUT_2	R/W	1	OUT Voltage: 400 mV step if SYS_SEL is 01 or 11
B2	SYS_VOUT_1	R/W	0	OUT Voltage: 200 mV step if SYS_SEL is 01 or 11
B1	SYS_VOUT_0	R/W	1	OUT Voltage: 100 mV step if SYS_SEL is 01 or 11
B0 (LSB)			0	

SW_VOUT Bits: Use SYS_SEL and SYS_VOUT bits to set the output on SYS. The SYS voltage is calculated using the following equation:
See table below for all VOUT values that can be programmed through SYS_SEL and SYS_VOUT.
If SYS_SEL = 01, then SYS = 1.30 V + SYS_VOUTCODE x 100 mV.
If SYS_SEL = 11, then SYS = 1.80 V + SYS_VOUTCODE x 100 mV.

Table 18. SYS_SEL Codes

SYS_SEL	SYS_VOUT	TYP	UNIT
00	0000	1.1	V
00	0001	1.2	V
00	0010	1.25	V
00	0011	1.333	V
00	0100	1.417	V
00	0101	1.5	V
00	0110	1.583	V
00	0111	1.667	V
00	1000	1.75	V
00	1001	1.833	V
00	1010	1.917	V
00	1011	2	V
00	1100	2.083	V
00	1101	2.167	V
00	1110	2.25	V
00	1111	2.333	V
01	0000	1.3	V
01	0001	1.4	V
01	0010	1.5	V
01	0011	1.6	V
01	0100	1.7	V
01	0101	1.8	V
01	0110	1.9	V

Table 18. SYS_SEL Codes (continued)

SYS_SEL	SYS_VOUT	TYP	UNIT
01	0111	2	V
01	1000	2.1	V
01	1001	2.2	V
01	1010	2.3	V
01	1011	2.4	V
01	1100	2.5	V
01	1101	2.6	V
01	1110	2.7	V
01	1111	2.8	V
10	0000	1.5	V
10	0001	1.583	V
10	0010	1.667	V
10	0011	1.75	V
10	0100	1.833	V
10	0101	1.917	V
10	0110	2	V
10	0111	2.083	V
10	1000	2.167	V
10	1001	2.25	V
10	1010	2.333	V
10	1011	2.417	V
10	1100	2.5	V
10	1101	2.583	V
10	1110	2.667	V
10	1111	2.75	V
11	0000	1.8	V
11	0001	1.9	V
11	0010	2	V
11	0011	2.1	V
11	0100	2.2	V
11	0101	2.3	V
11	0110	2.4	V
11	0111	2.5	V
11	1000	2.6	V
11	1001	2.7	V
11	1010	2.8	V
11	1011	2.9	V
11	1100	3	V
11	1101	3.1	V
11	1110	3.2	V
11	1111	3.3	V

9.6.8 Load Switch and LDO Control Register

Memory location 0x07h, Reset State: 0111 110x (bq25120)

Figure 30. Load Switch and LDO Control Register

7 (MSB)	6	5	4	3	2	1	0 (LSB)
0	1	1	1	1	1	0	x
R/W	R/W	R/W	R/W	R/W	R/W	R	R

LEGEND: R/W = Read/Write; R = Read only; -n = value after reset

Table 19. Load Switch and LDO Control Register

Bit	Field	Type	Reset	Description
B7 (MSB)	EN_LS_LDO	R/W	0	0 – Disable LS/LDO 1 – Enable LS/LDO
B6	LS_LDO_4	R/W	1	LS/LDO Voltage: 1600 mV
B5	LS_LDO_3	R/W	1	LS/LDO Voltage: 800 mV
B4	LS_LDO_2	R/W	1	LS/LDO Voltage: 400 mV
B3	LS_LDO_1	R/W	1	LS/LDO Voltage: 200 mV
B2	LS_LDO_0	R/W	1	LS/LDO Voltage: 100 mV
B1			0	
B0 (LSB)	MRRESET_VIN	R/W	x	0 – Reset sent when \overline{MR} Reset time is met 1 – Reset sent when \overline{MR} Reset time is met and $V_{UVLO} + V_{SLP} < V_{IN} < V_{OVP}$

LS_LDO Bits: Use LS_LDO bits to set the LS/LDO output. The LS/LDO voltage is calculated using the following equation: $LS/LDO = 0.8 V + LS_LDOCODE \times 100 mV$. If a value greater than 3.3 V is written, the setting goes to pass-through mode where $LS/LDO = V_{INLS} - V_{DROPOUT}$. The LS_LDO output can only be changed when the EN_LS_LDO and LSCTRL pin has disabled the output.

9.6.9 Push-button Control Register

Memory location 0x08h, Reset State: 0110 10xx (bq25120)

Figure 31. Push-button Control Register

7 (MSB)	6	5	4	3	2	1	0 (LSB)
0	1	1	0	1	0	x	x
R/W	R/W	R/W	R/W	R/W	R/W	R	R

LEGEND: R/W = Read/Write; R = Read only; -n = value after reset

Table 20. Push-button Control Register

Bit	Field	Type	Reset	Description
B7 (MSB)	MRWAKE1	R/W	0	\overline{MR} Timer adjustment for WAKE1: 0 – 50 ms < \overline{MR} < 500 ms 1 – 500 ms < \overline{MR} < 1000 ms
B6	MRWAKE2	R/W	1	\overline{MR} Timer adjustment for WAKE2: 0 – 1000 ms < \overline{MR} < 1500 ms 1 – 1500 ms < \overline{MR} < 2000 ms
B5	MRREC	R/W	1	0 – After Reset, device enters Ship mode 1 – After Reset, device enters Hi-Z Mode
B4	MRRESET_1	R/W	0	\overline{MR} Timer adjustment for reset: 00 – 4 s ± 10% 01 – 8 s ± 10% 10 – 10 s ± 10% 11 – 14 s ± 10%
B3	MRRESET_0	R/W	1	
B2	PGB_MR	R/W	0	0 – Output functions as \overline{PG} 1 – Output functions as voltage shifted push-button (\overline{MR}) input
B1	WAKE1	R	x	1 – WAKE1 status. Indicates when the device meets the WAKE1 conditions, and is cleared after I ² C read.
B0 (LSB)	WAKE2	R	x	1 – WAKE2 status. Indicates when the device meets the WAKE2 conditions, and is cleared after I ² C read.

9.6.10 ILIM and Battery UVLO Control Register

Memory location 0x09h, Reset State: 0000 1010 (bq25120)

Figure 32. ILIM and Battery UVLO Control Register

7 (MSB)	6	5	4	3	2	1	0 (LSB)
0	0	0	0	1	0	1	0
Write	R/W	R/W	R/W	R/W	R/W	R/W	R/W

LEGEND: R/W = Read/Write; R = Read only; -n = value after reset

Table 21. ILIM and Battery UVLO Control Register, Memory Location 1001

Bit	Field	Type	Reset	Description
B7 (MSB)	RESET	Write only	0	Write: 1- Reset all registers to default values 0 – No effect Read: Always get 0
B6		R/W	0	N/A
B5	INLIM_2	R/W	0	Input Current Limit: 200 mA
B4	INLIM_1	R/W	0	Input Current Limit: 100 mA
B3	INLIM_0	R/W	1	Input Current Limit: 50 mA
B2	BUVLO_2	R/W	0	000, 001, 010: BUVLO = 3 V
B1	BUVLO_1	R/W	1	011: BUVLO = 2.8 V 100: BUVLO = 2.6 V
B0 (LSB)	BUVLO_0	R/W	0	101: BULVO = 2.4 V 110: BUVLO = 2.2 V 111: BUVLO = Disabled

 INLIM Bits: Use INLIM bits to set the input current limit. The $I_{(INLIM)}$ is calculated using the following equation: $I_{(INLIM)} = 50 \text{ mA} + I_{(INLIM)CODE} \times 50 \text{ mA}$. The default is programmed by the external resistor on ILIM, or if not populated and tied to GND, by OTP.

9.6.11 Voltage Based Battery Monitor Register

Memory location 0x0Ah, Reset State: 0xxx xxxx (bq25120)

Figure 33. Voltage Based Battery Monitor Register

7 (MSB)	6	5	4	3	2	1	0 (LSB)
0	x	x	x	x	x	x	x
R/W	R	R	R	R	R	R	R

LEGEND: R/W = Read/Write; R = Read only; -n = value after reset

Table 22. Voltage Based Battery Monitor Register, Memory Location 1010

Bit	Field	Type	Reset	Description
B7 (MSB)	VBMON_READ	R/W	0	Write 1 to initiate a new VBATREG reading. Read always 0.
B6	VBMON_RANGE_1	R	x	11 – 90% to 100% of VBATREG
B5	VBMON_RANGE_0	R	x	10 – 80% to 90% of VBATREG 01 – 70% to 80% of VBATREG 00 – 60% to 70% of VBATREG
B4	VBMON_TH_2	R	x	111 – Above 8% of VBMON_RANGE
B3	VBMON_TH_1	R	x	110 – Above 6% of VBMON_RANGE
B2	VBMON_TH_0	R	x	011 – Above 4% of VBMON_RANGE 010 – Above 2% of VBMON_RANGE 001 – Above 0% of VBMON_RANGE
B1		R	x	N/A
B0 (LSB)		R	x	N/A

The VBMON registers are used to determine the battery voltage. Before entering a low power state, the device will determine the voltage level by starting at VBMON_RANGE 11 (90% to 100%), and if VBMON_TH of 000 is read, then it will move to VBMON_RANGE 10 (80% to 90%) and continue until a non 000 value of VBMON_TH is found. If this does not happen, then VBMON_RANGE and VBMON_TH will be written with 00 000. The VBMON_READ bit can be used to initiate a new reading by writing a 1 to it. Example: A reading of 10 011 indicated a VBAT voltage of between 84% and 86% of the VBATREG setting.

9.6.12 VIN_DPM and Timers Register

Memory location 0x0Bh, Reset State: 0100 1010 (bq25120)

Figure 34. VIN_DPM and Timers Register

7 (MSB)	6	5	4	3	2	1	0 (LSB)
0	1	0	0	1	0	1	0
R/W	R/W	R/W	R/W	R/W	R/W	R/W	R/W

LEGEND: R/W = Read/Write; R = Read only; -n = value after reset

Table 23. VIN_DPM and Timers Register

Bit	Field	Type	Reset	Description
B7 (MSB)	VINDPM_ON	R/W	0	0 - enable VINDPM 1 - disable VINDPM
B6	VINDPM_2	R/W	1	Input V _(IN_DPM) voltage: 400 mV
B5	VINDPM_1	R/W	0	Input V _(IN_DPM) voltage: 200 mV
B4	VINDPM_0	R/W	0	Input V _(IN_DPM) voltage: 100 mV
B3	2XTMR_EN	R/W	1	0 – Timer is not slowed at any time 1 – Timer is slowed by 2x when in any control other than CC or CV
B2	TMR_1	R/W	0	Safety Timer Time Limit 00 – 30 minute fast charge 01 – 3 hour fast charge 10 – 9 hour fast charge 11 – Disable safety timers
B1	TMR_0	R/W	1	
B0 (LSB)			0	

The VINDPM threshold is set using the following equation: $VINDPM = 4.2 + VINDPM_CODE \times 100 \text{ mV}$

10 Application and Implementation

NOTE

Information in the following applications sections is not part of the TI component specification, and TI does not warrant its accuracy or completeness. TI's customers are responsible for determining suitability of components for their purposes. Customers should validate and test their design implementation to confirm system functionality.

10.1 Application Information

A typical design is shown in Figure 35. This design uses the BQ25120 with external resistors for ILIM, IPRETERM, and ISET. These are not needed if these values are set with a host controller through I²C commands. This design also shows the TS resistors, which is also optional.

When powering up in default mode the battery voltage is the default for the part (4.2 V), the SYS output is the default (1.8 V). External resistors set the charge current to 40 mA, the termination current to 10% (4 mA), and the input current limit to 100 mA. If the I²C interface is used the part goes to the internal default settings until changed by the host.

10.2 Typical Application

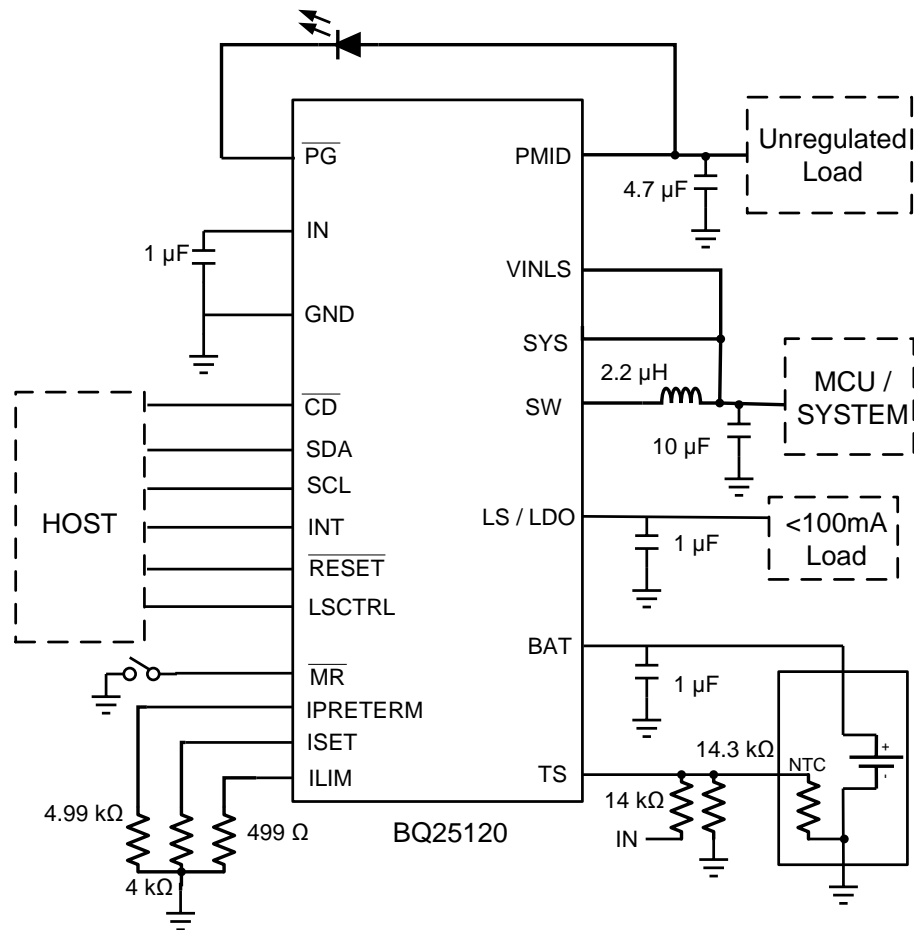

Copyright © 2016, Texas Instruments Incorporated

Figure 35. Typical Application Circuit

Typical Application (continued)

10.2.1 Design Requirements

This application is for a low power system that has varying loads from less than 10 mA up to 300 mA. It must work with a valid adaptor or USB power input. Below are some of the key components that are needed in normal operation. For this example, the fast charge current is 50 mA, input current limit is 400 mA and the pre-charge and termination current is 10% of the fast charge current.

- Supply voltage = 3.4 V to 20 V
- Fast charge current is default to 10 mA with ISET pin shorted to ground. To program the fast charge current, connect an external resistor from ISET to ground.
- Input current limit is default to 100 mA with ILIM pin shorted to ground. To program the input current limit, connect an external resistor from ILIM to ground.
- Termination current threshold is default to 2 mA with IPRETERM pin shorted to ground. To program the input current limit, connect an external resistor from IPRETERM to ground.
- A 2.2- μ H inductor is needed between SW pin and SYS pin for PWM output.
- TS- Battery temperature sense needs a NTC connected on TS pin.

10.2.2 Detailed Design Procedure

See [Figure 35](#) for an example of the application diagram.

10.2.2.1 Default Settings

- Connect ISET, ILIM and IPRETERM pins to ground to program fast charge current to 10mA, input current limit to 100mA and pre-charge/termination current to 2 mA.
- BAT_UVLO = 3 V.
- VSYS = 1.8 V
- LS/LDO is LS
- VBREG = 4.2 V
- VIN_DPM is enabled and VIN_DPM Threshold = 4.6 V.
- Safety Timer = 3 hr
- If the function is not needed, connect TS to the center tab of the resistor divider between V_{IN} and the ground. (pull up resistor = 14 k Ω , pull down resistor = 14.3 k Ω)

10.2.2.2 Choose the Correct Inductance and Capacitance

Refer to the [Buck \(PWM\) Output](#) section for the detailed procedure to determine the optimal inductance and capacitance for the buck output.

10.2.2.3 Calculations

10.2.2.3.1 Program the Fast Charge Current (ISET)

$$R_{ISET} = K_{ISET} / I_{CHG} \quad (10)$$

$K_{ISET} = 200 \text{ A}\Omega$ from the [Specifications](#) table

$$R_{ISET} = 200 \text{ A}\Omega / 0.05\text{A} = 4 \text{ k}\Omega \quad (11)$$

Select the closest standard value, which in this case is 4.99 k Ω . Connect this resistor between ISET pin and GND.

10.2.2.3.2 Program the Input Current Limit (ILIM)

$$R_{ILIM} = K_{ILIM} / I_{L_MAX} \quad (12)$$

$K_{ILIM} = 200 \text{ A}\Omega$ from the [Specifications](#) table

$$R_{ILIM} = 200 \text{ A}\Omega / 0.4\text{A} = 500 \Omega \quad (13)$$

Select the closest standard value, which in this case is 499 Ω . Connect this resistor between ILIM pin and GND.

Typical Application (continued)

10.2.2.3.3 Program the Pre-charge/termination Threshold (IPRETERM)

According to [Table 3](#), the RIPRETERM is 4990 Ω for 10% termination threshold. Therefore, connect a 4.99 k Ω resistor between IPRETERM pin and GND.

10.2.2.3.4 TS Resistors (TS)

The voltage at TS is monitored to determine that the battery is at a safe temperature during charging. This device uses JEITA temperature profile which has four temperature thresholds. Refer to [Specifications](#) for the detailed thresholds number.

The TS circuit is shown in [Figure 16](#). The resistor values can be calculated using [Equation 1](#) and [Equation 2](#).

Typical Application (continued)

10.2.3 Application Performance Curves

10.2.3.1 Charger Curves

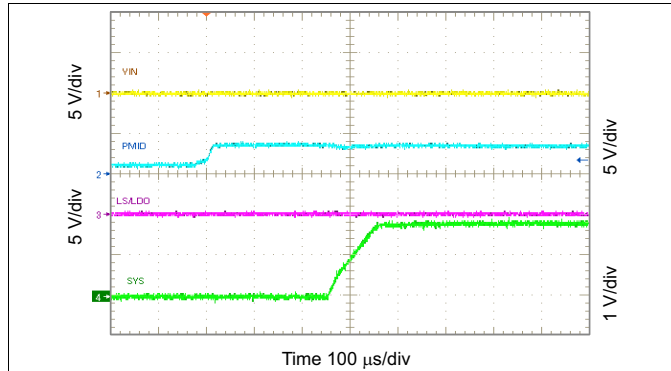

Figure 36. Battery Connected to V_{BAT}

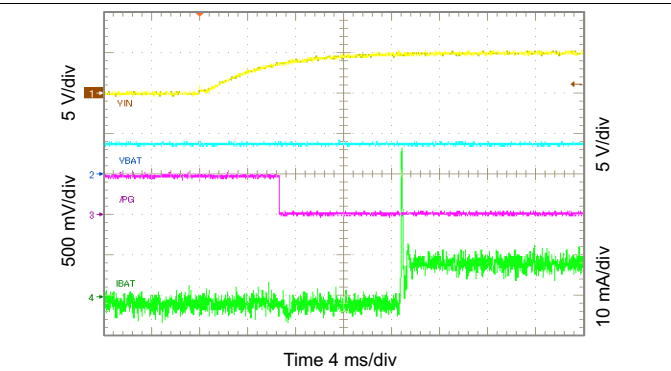

Figure 37. Power Supply Connected to V_{IN}

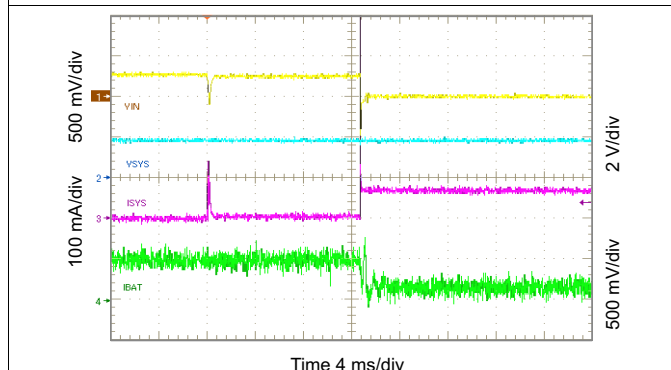

Figure 38. Entering DPPM Mode

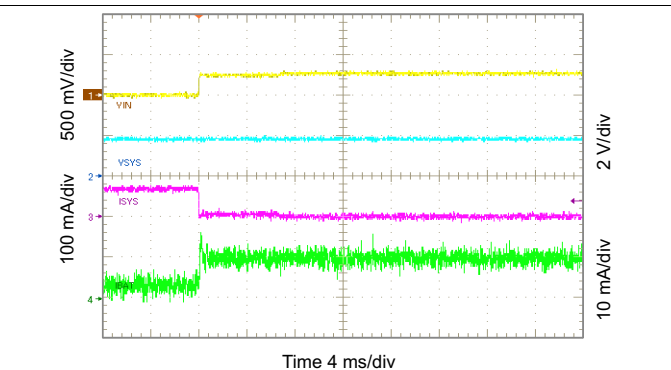

Figure 39. Exiting DPPM Mode

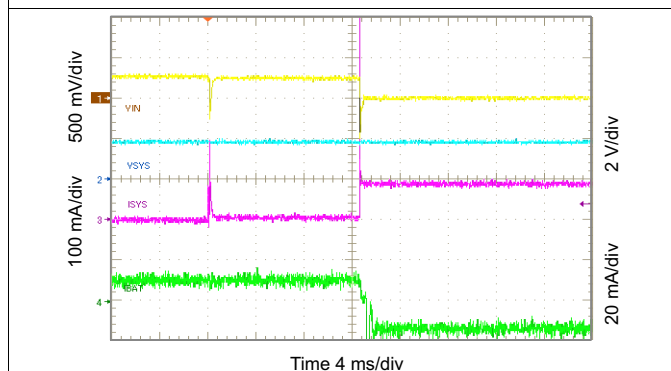

Figure 40. Entering Battery Supplement Mode

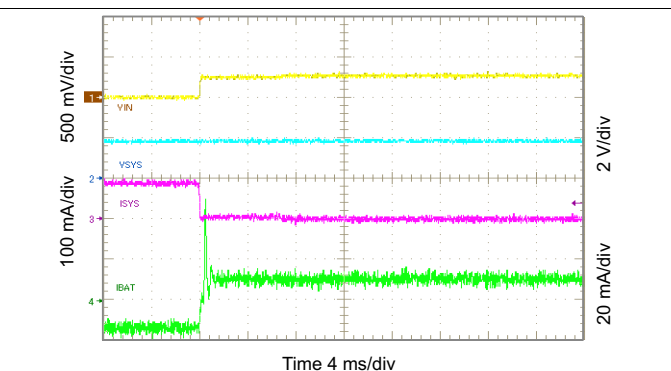
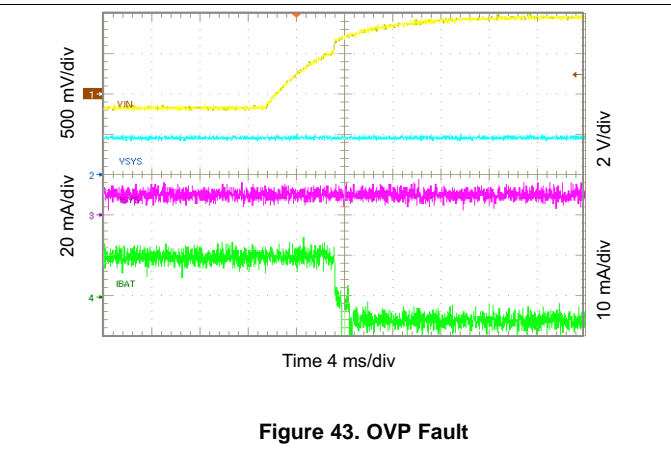
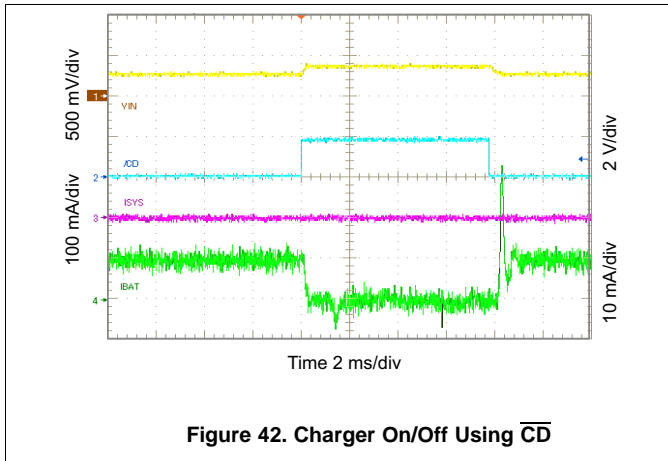

Figure 41. Exiting Battery Supplement Mode

Typical Application (continued)



Typical Application (continued)

10.2.3.2 SYS Output Curves

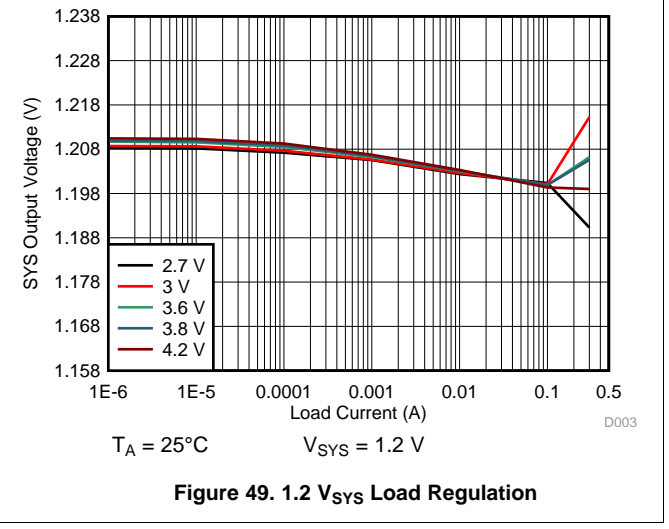
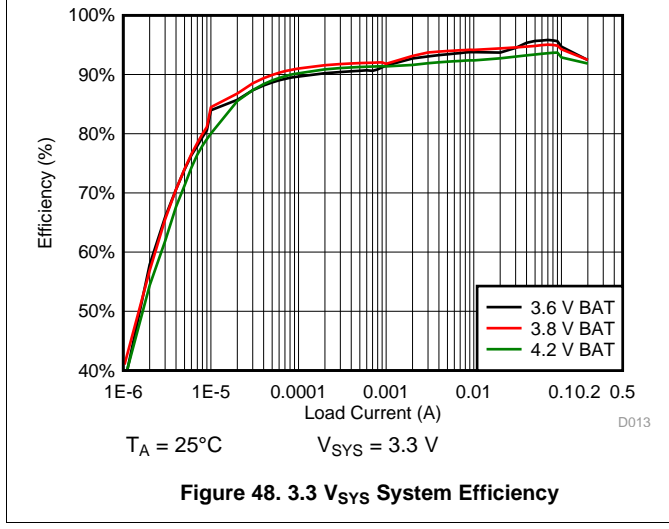
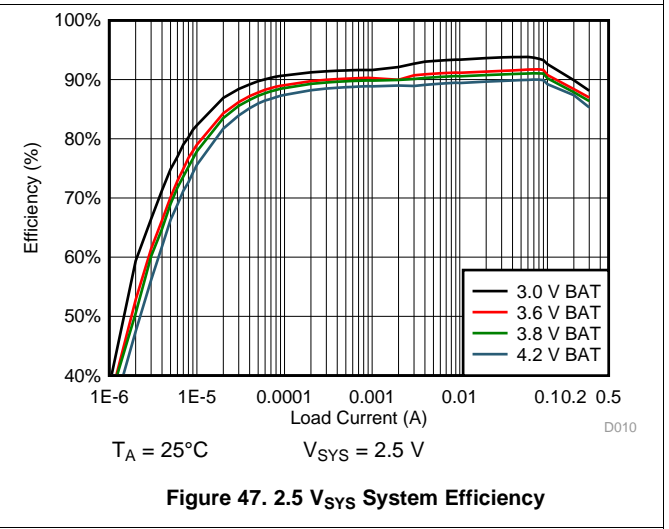
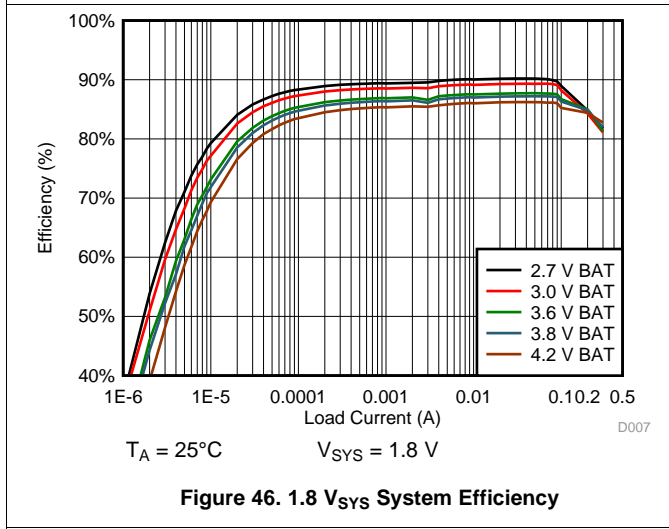
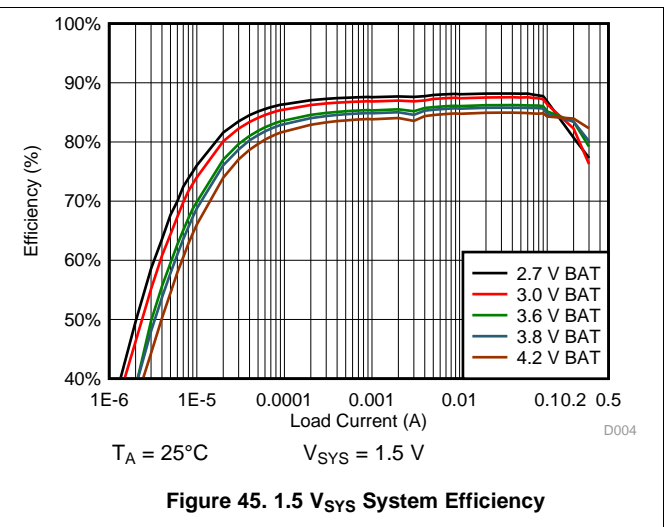
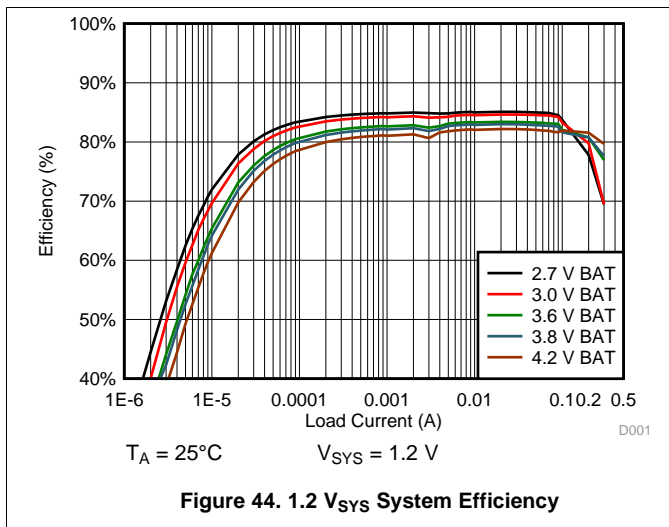

Typical Application (continued)

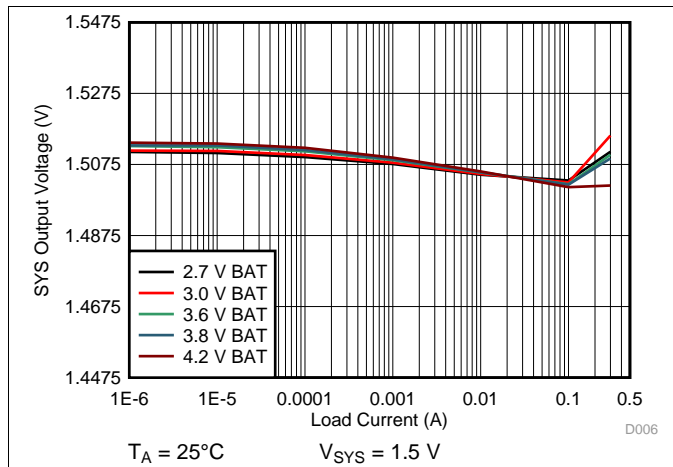

Figure 50. 1.5 V_{sys} Load Regulation

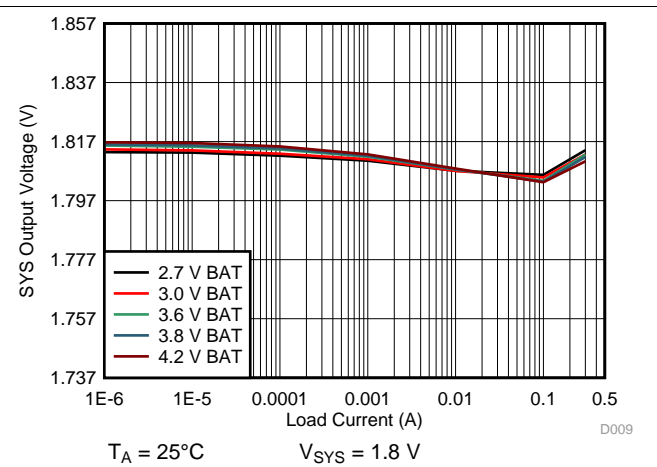

Figure 51. 1.8 V_{sys} Load Regulation

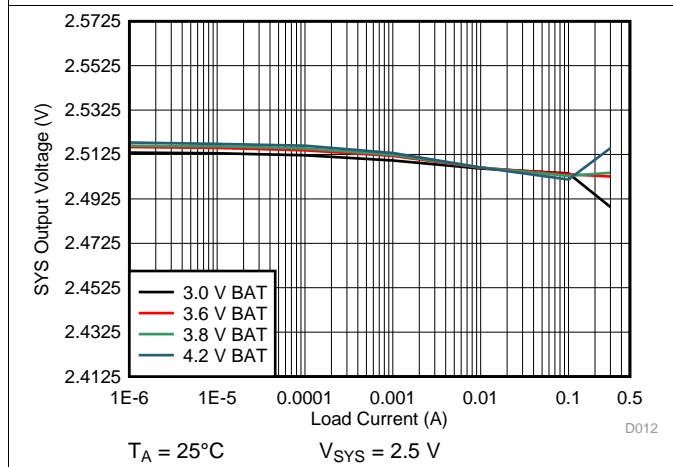

Figure 52. 2.5 V_{sys} Load Regulation

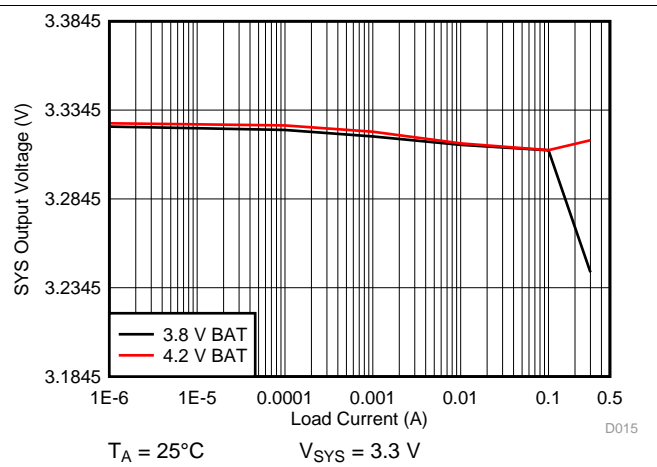

Figure 53. 3.3 V_{sys} Load Regulation

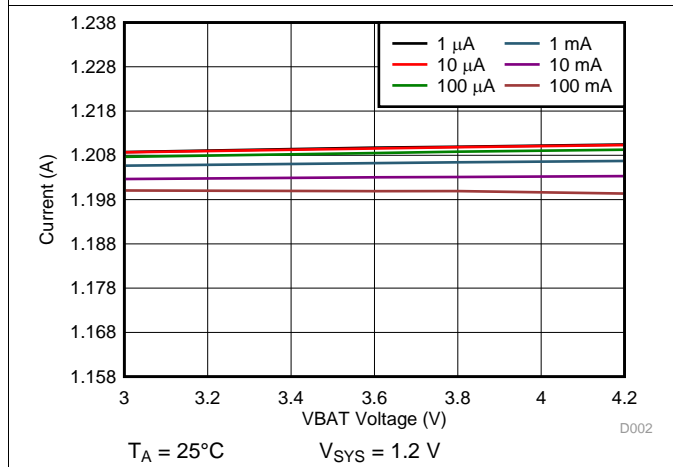

Figure 54. 1.2 V_{sys} Line Regulation

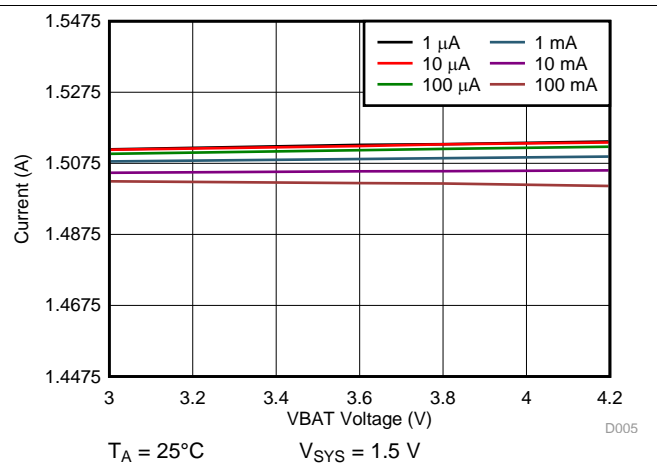

Figure 55. 1.5 V_{sys} Line Regulation

Typical Application (continued)

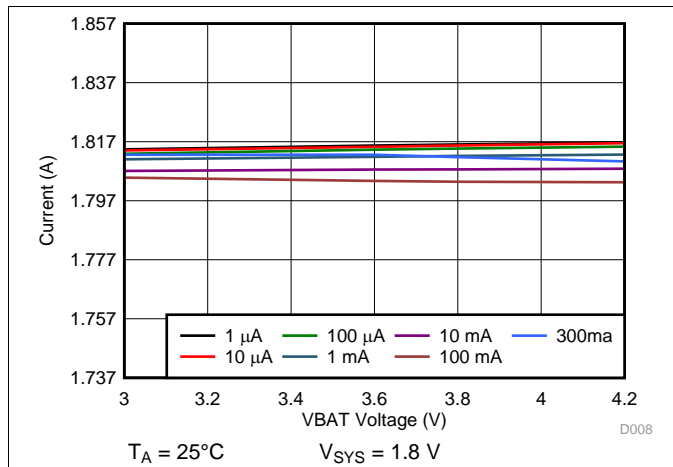

Figure 56. 1.8 V_{sys} Line Regulation

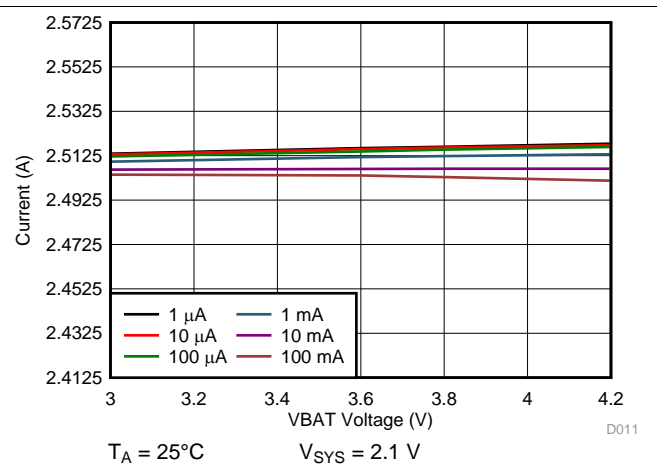

Figure 57. 2.1 V_{sys} Line Regulation

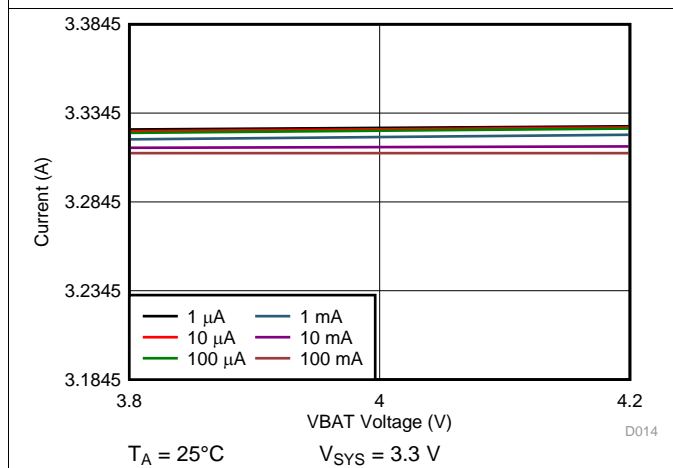

Figure 58. 3.3 V_{sys} Line Regulation

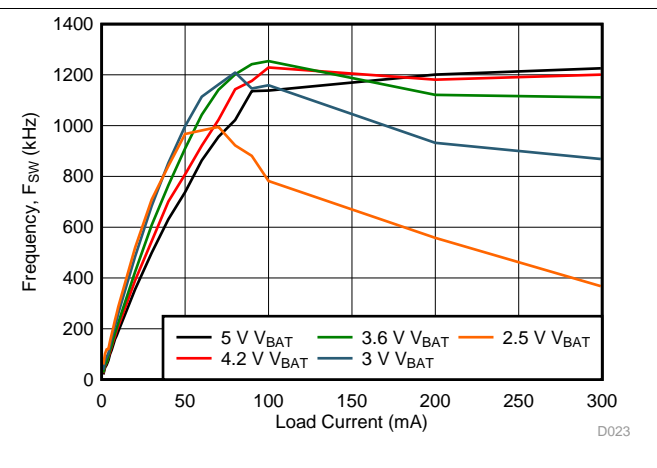

Figure 59. 1.8 V_{sys} Switching Frequency vs Load Current

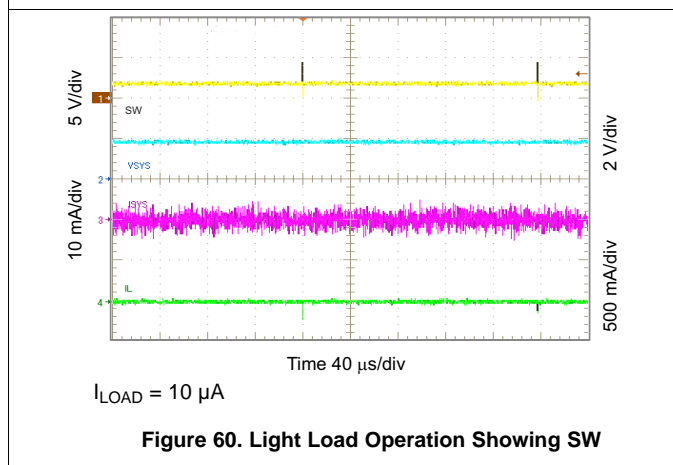

Figure 60. Light Load Operation Showing SW

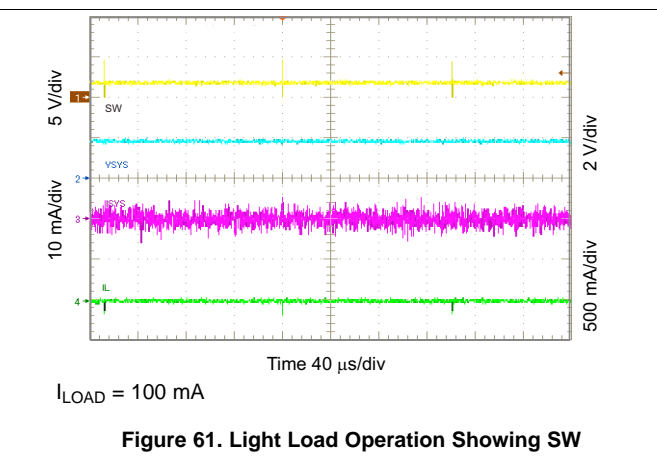

Figure 61. Light Load Operation Showing SW

Typical Application (continued)

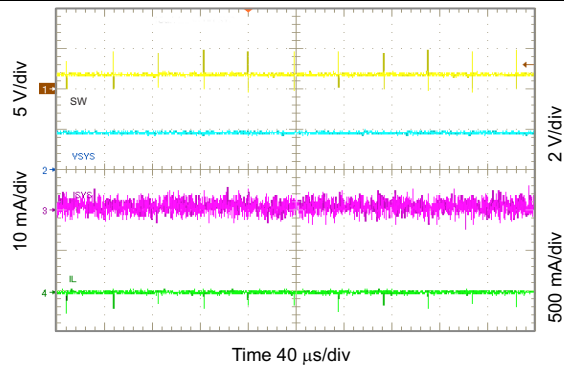

Figure 62. Light Load Operation Showing SW

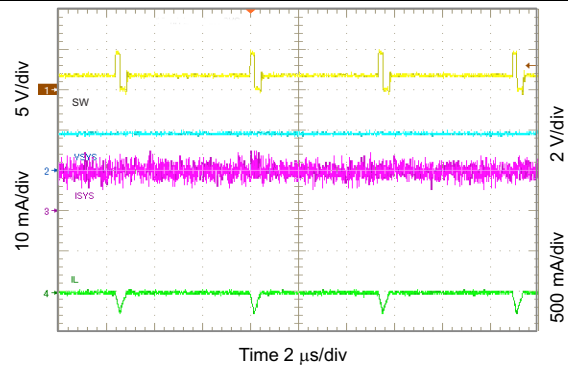

Figure 63. Light Load Operation Showing SW

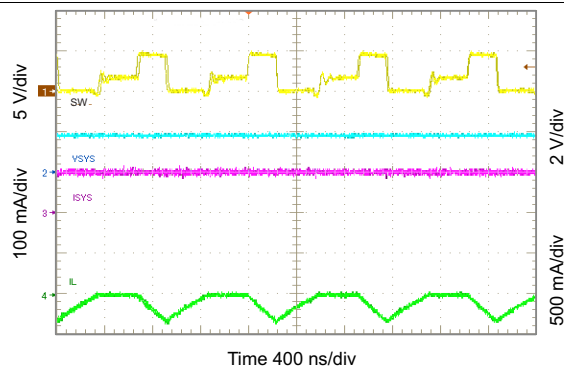

Figure 64. Light Load Operation Showing SW

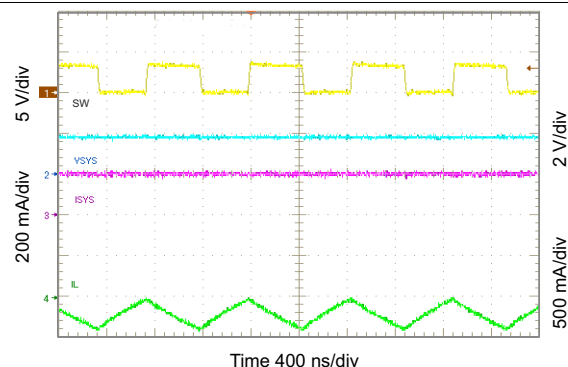

Figure 65. Light Load Operation Showing SW

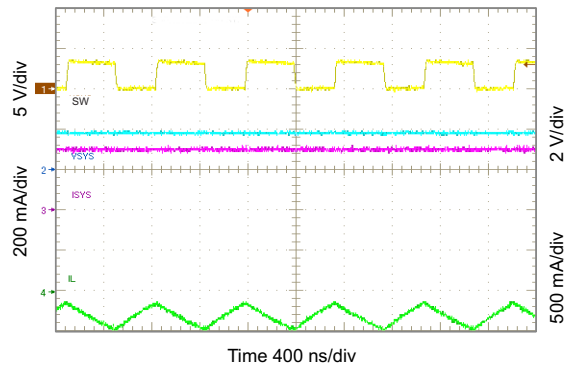

Figure 66. Light Load Operation Showing SW

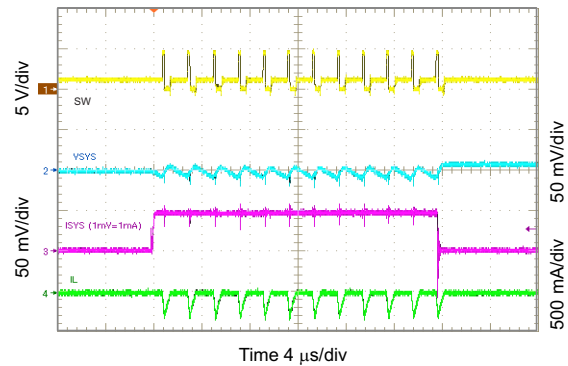
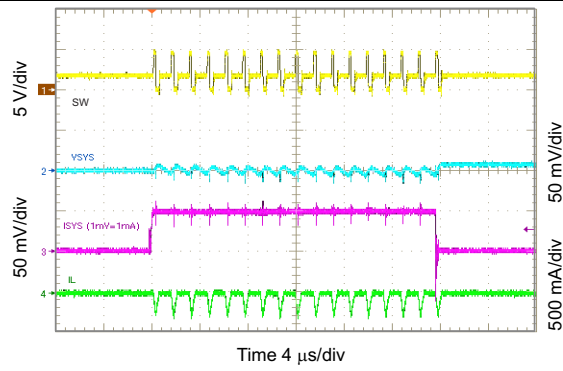

Figure 67. 1.2 V_{SYS} Load Transient, 0 to 50 mA

Typical Application (continued)



$V_{SYS} = 1.8\text{ V}$

Figure 68. 1.8 V_{SYS} Load Transient, 0 to 50 mA

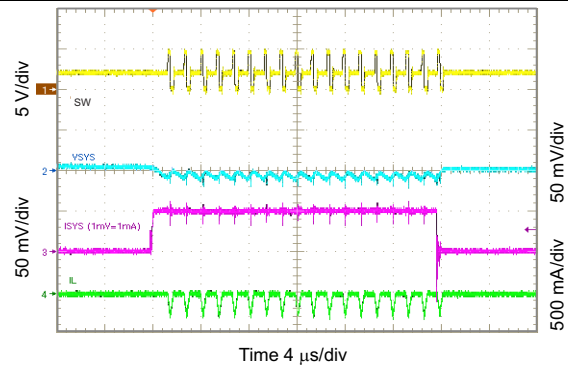

$V_{SYS} = 2.1\text{ V}$

Figure 69. 2.1 V_{SYS} Load Transient, 0 to 50 mA

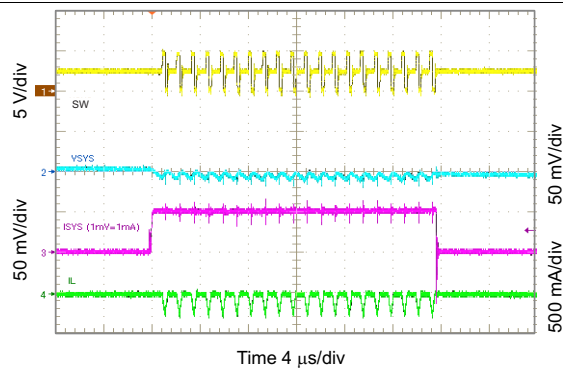

$V_{SYS} = 2.5\text{ V}$

Figure 70. 2.5 V_{SYS} Load Transient, 0 to 50 mA

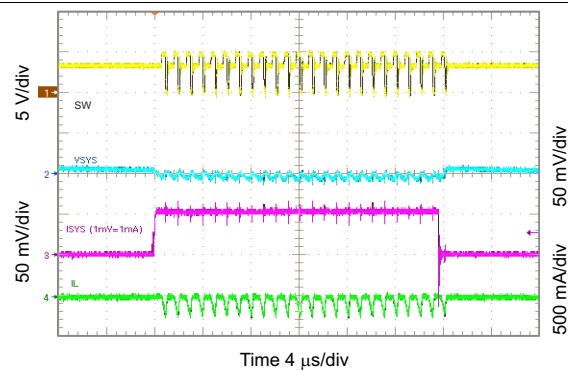

$V_{SYS} = 3.3\text{ V}$

Figure 71. 3.3 V_{SYS} Load Transient, 0 to 50 mA

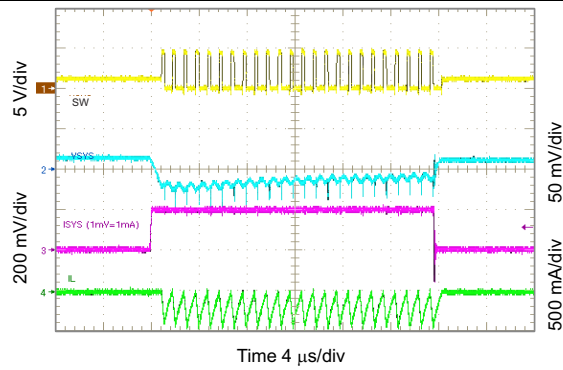

$V_{SYS} = 1.2\text{ V}$

Figure 72. 1.2 V_{SYS} Load Transient, 0 to 200 mA

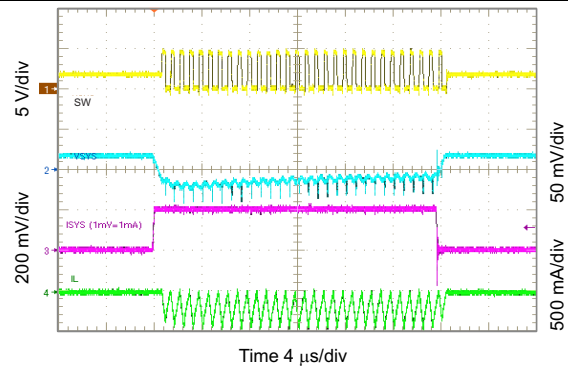

$V_{SYS} = 1.8\text{ V}$

Figure 73. 1.8 V_{SYS} Load Transient, 0 to 200 mA

Typical Application (continued)

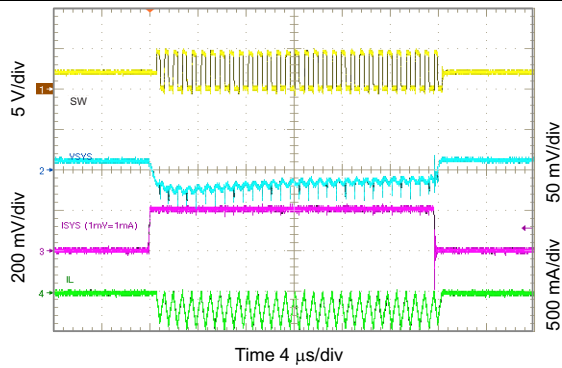

$V_{SYS} = 2.1\text{ V}$

Figure 74. 2.1 V_{SYS} Load Transient, 0 to 200 mA

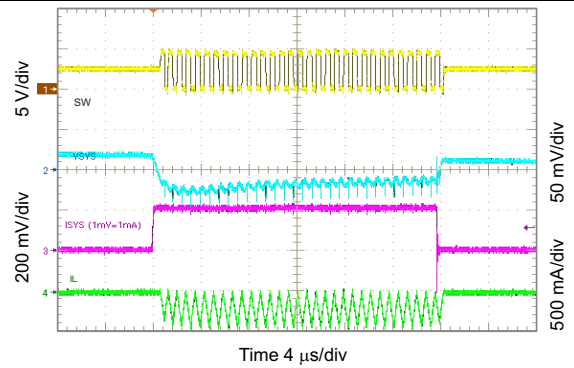

$V_{SYS} = 2.5\text{ V}$

Figure 75. 2.5 V_{SYS} Load Transient, 0 to 200 mA

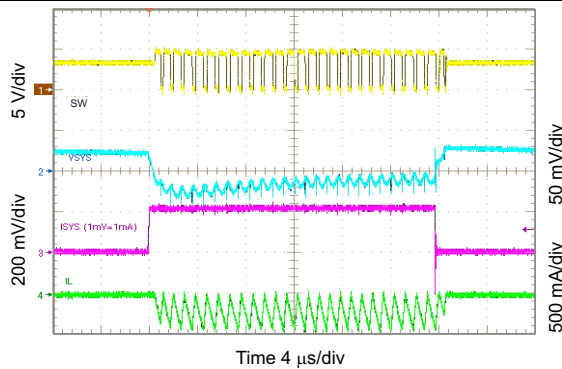

$V_{SYS} = 3.3\text{ V}$

Figure 76. 3.3 V_{SYS} Load Transient, 0 to 200 mA

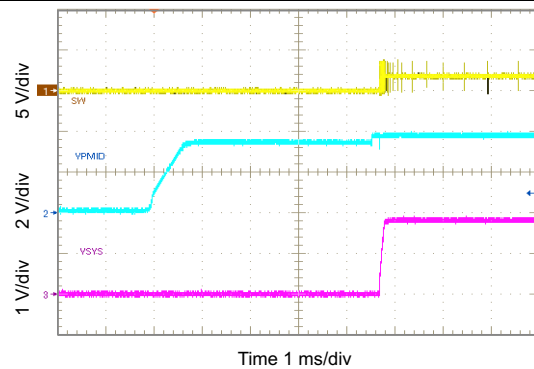

Figure 77. Startup Showing SS on SYS in PWM Mode

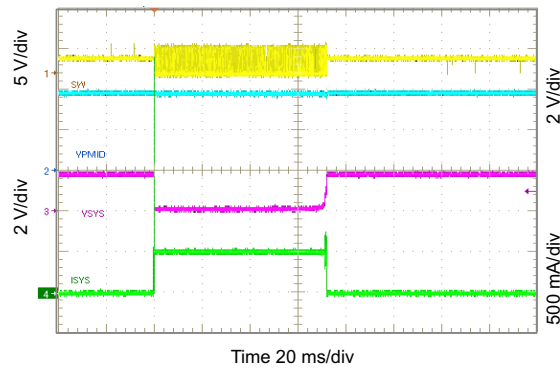
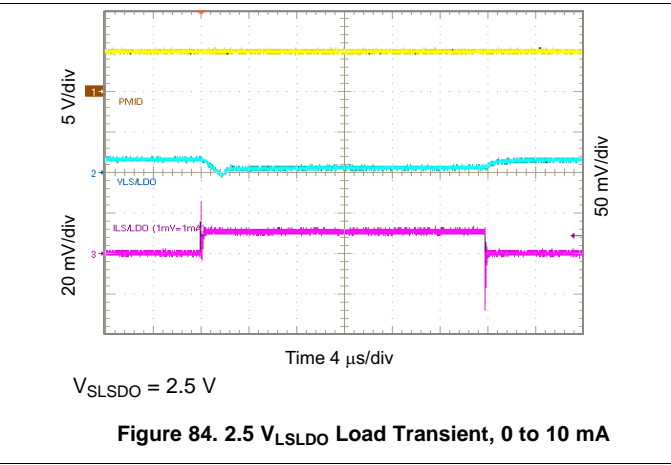
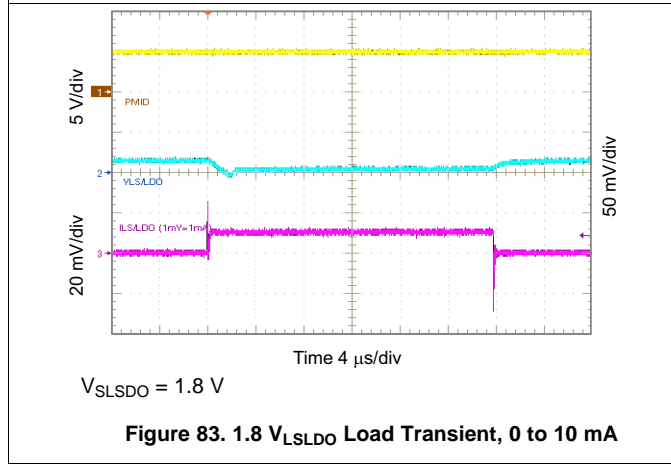
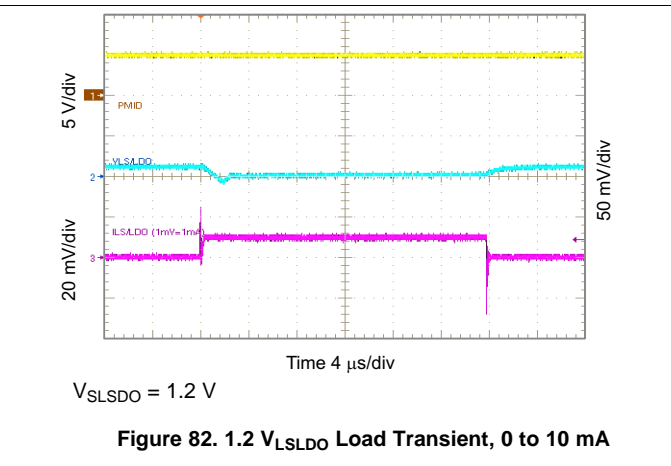
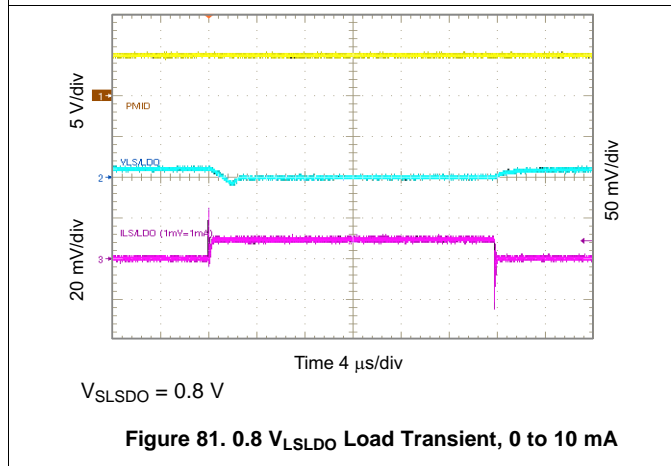
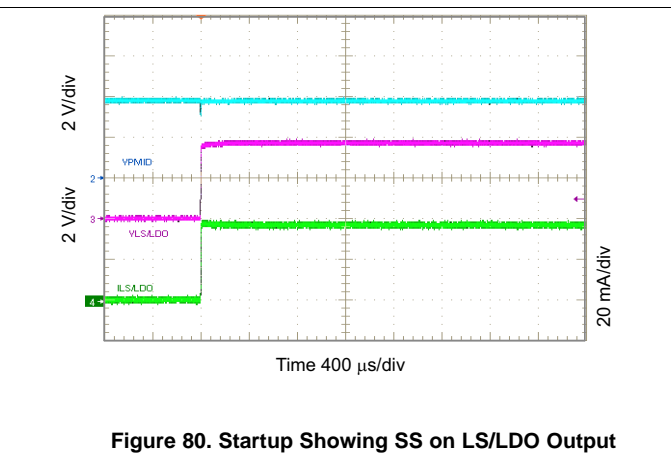
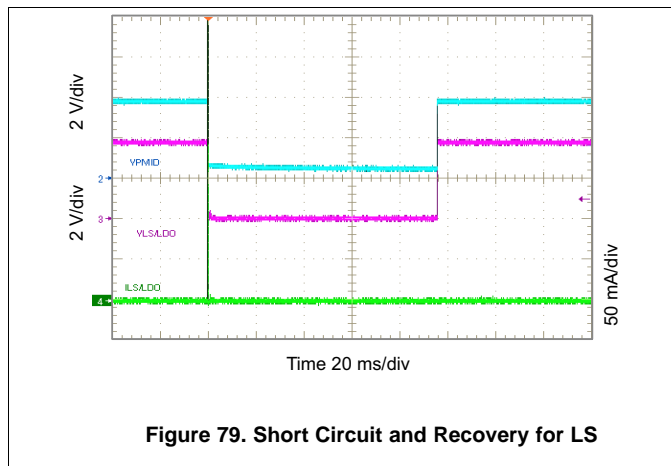

Figure 78. Short Circuit and Recovery for SYS

Typical Application (continued)

10.2.3.3 Load Switch Curves



Typical Application (continued)

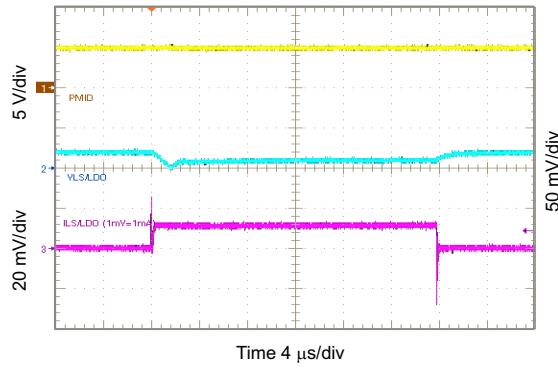

$V_{SLSDO} = 3.3\text{ V}$

Figure 85. 3.3 V_{LSLDO} Load Transient, 0 to 10 mA

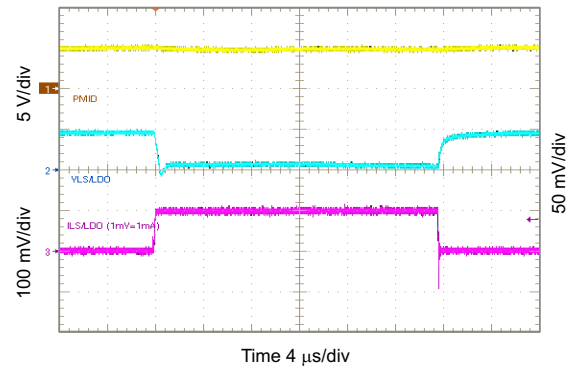

$V_{SLSDO} = 0.8\text{ V}$

Figure 86. 0.8 V_{LSLDO} Load Transient, 0 to 100 mA

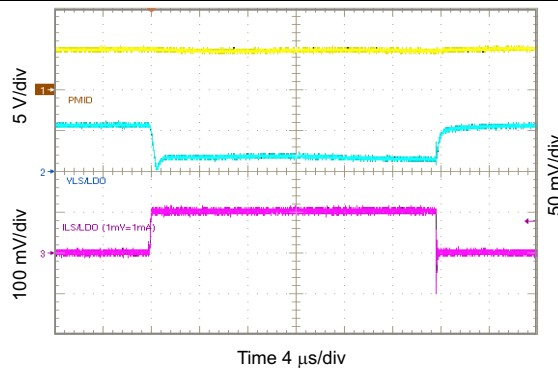

$V_{SLSDO} = 1.2\text{ V}$

Figure 87. 1.2 V_{LSLDO} Load Transient, 0 to 100 mA

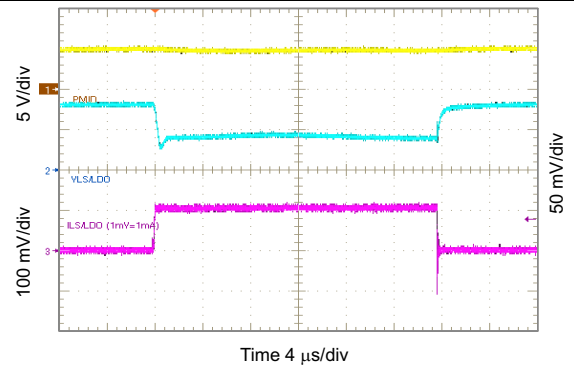

$V_{SLSDO} = 1.8\text{ V}$

Figure 88. 1.8 V_{LSLDO} Load Transient, 0 to 100 mA

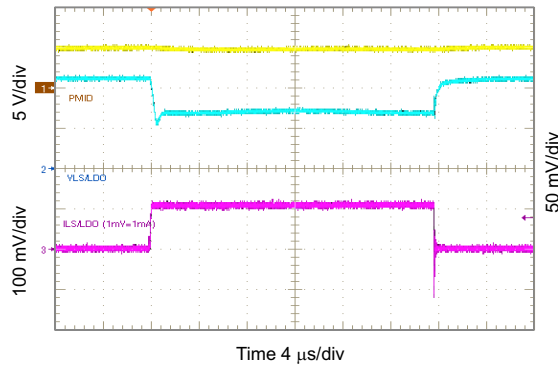

$V_{SLSDO} = 2.5\text{ V}$

Figure 89. 2.5 V_{LSLDO} Load Transient, 0 to 100 mA

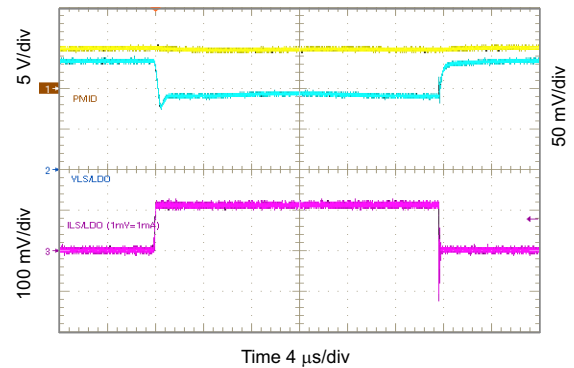

$V_{SLSDO} = 3.3\text{ V}$

Figure 90. 3.3 V_{LSLDO} Load Transient, 0 to 100 mA

Typical Application (continued)

10.2.3.4 LS/LDO Output Curves

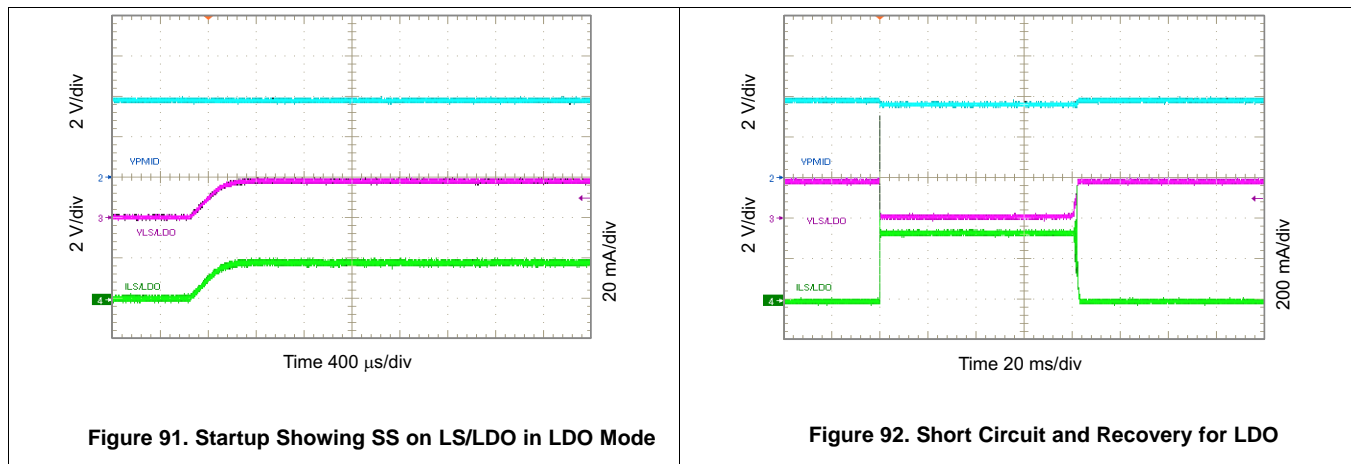

Figure 91. Startup Showing SS on LS/LDO in LDO Mode

Figure 92. Short Circuit and Recovery for LDO

Typical Application (continued)

10.2.3.5 Timing Waveforms Curves

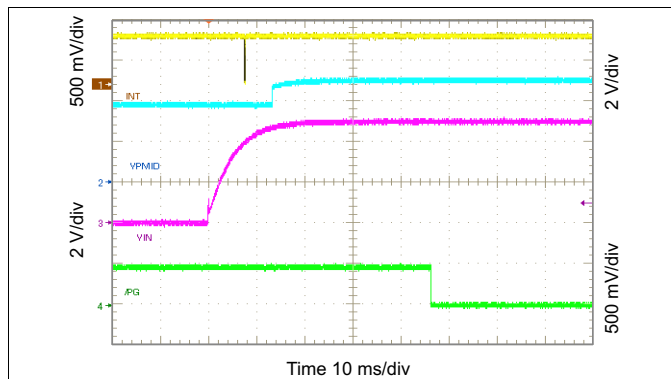

Figure 93. Show $\overline{\text{PG}}$ and $\overline{\text{INT}}$ Timing (VIN Insertion)

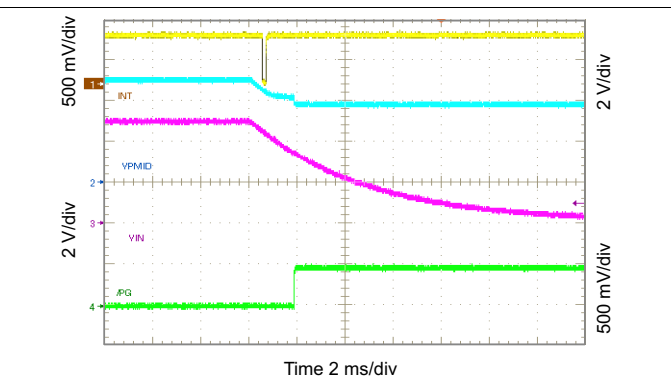

Figure 94. Show $\overline{\text{PG}}$ and $\overline{\text{INT}}$ Timing (VIN Removal)

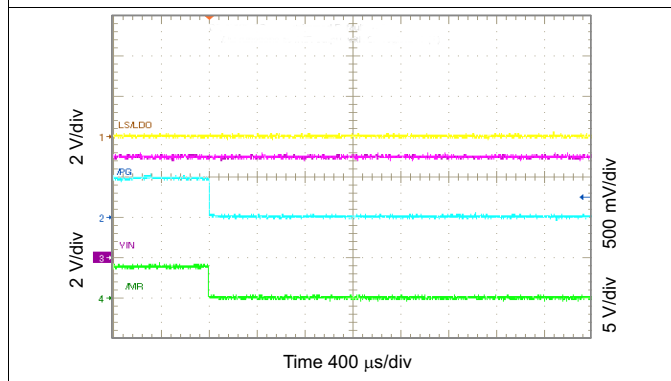

Figure 95. $\overline{\text{PG}}$ Functions as Shifted $\overline{\text{MR}}$ Output

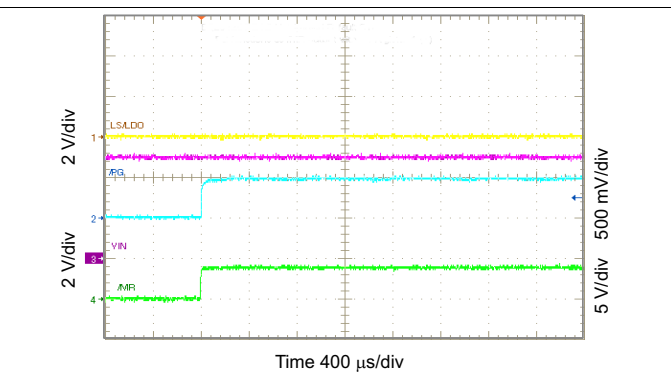

Figure 96. $\overline{\text{PG}}$ Functions as Shifted $\overline{\text{MR}}$ Output

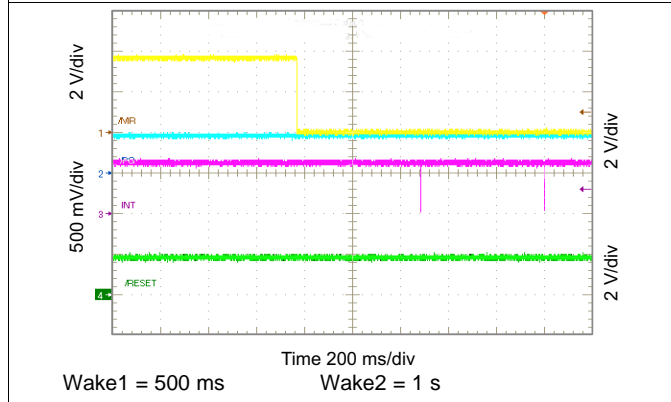

Figure 97. Show $\overline{\text{MR}}$ Timing

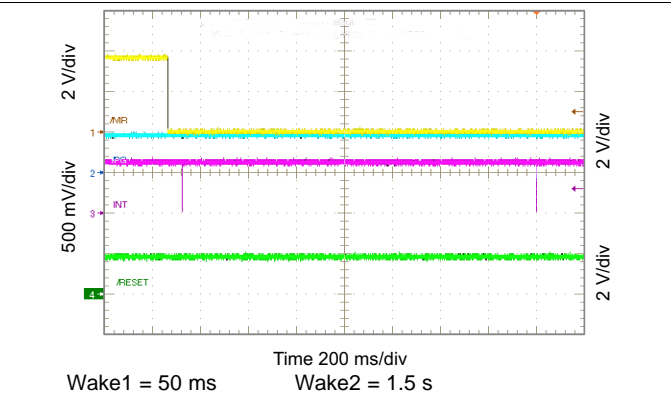
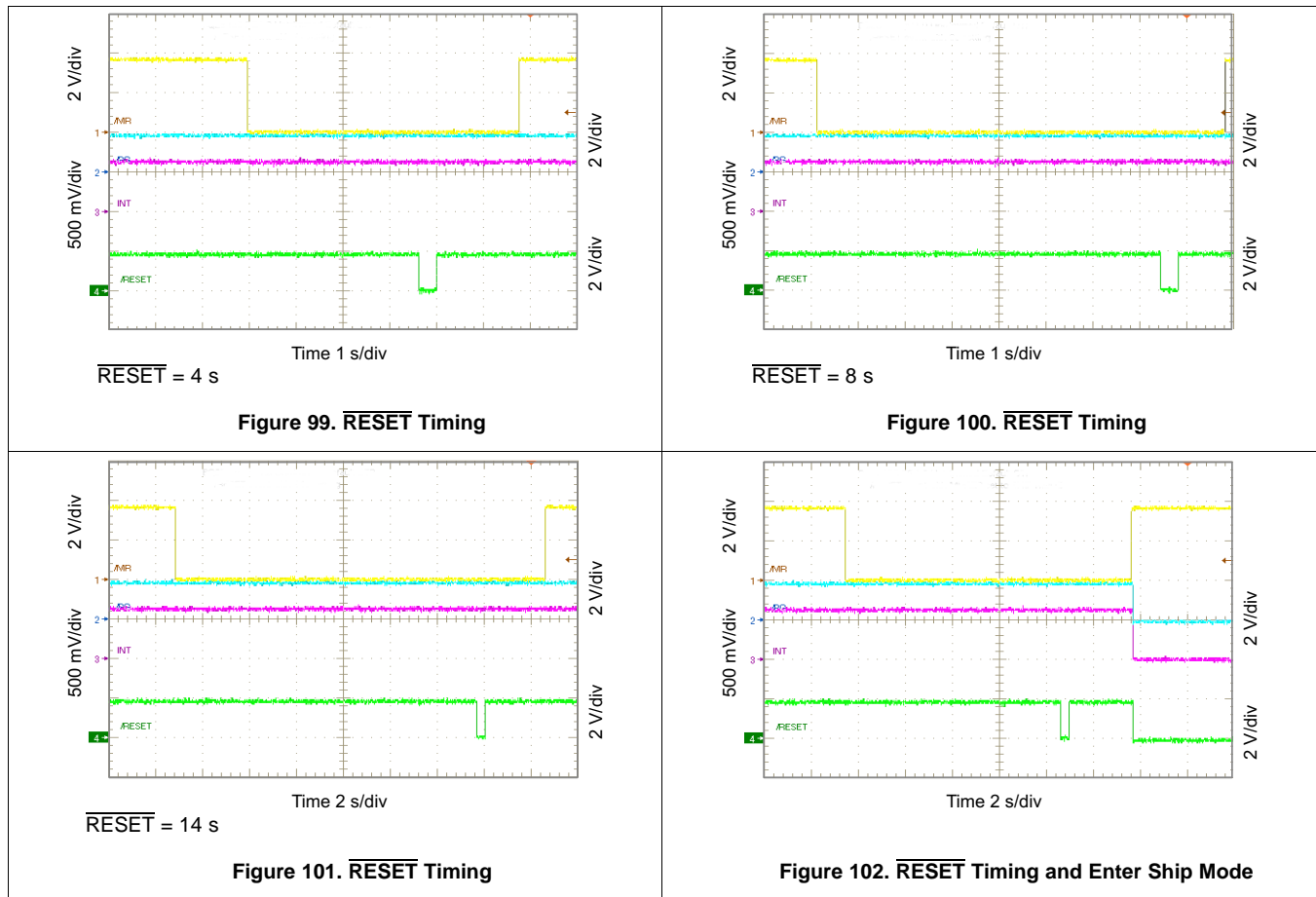

Figure 98. Show $\overline{\text{MR}}$ Timing

Typical Application (continued)



11 Power Supply Recommendations

It is recommended to use a power supply that is capable of delivering 5 V at the input current limit set by the BQ25120.

12 Layout

12.1 Layout Guidelines

- Keep the core components of the system close to each other and the device.
- Keep the PMID, IN, and SYS caps as close to their respective pins as possible. Place the bypass caps for PMID, SYS, and LSLDO close to the pins.
- Place the GNDs of the PMID and IN caps close to each other.
- Don't route so the power planes are interrupted.

12.2 Layout Example

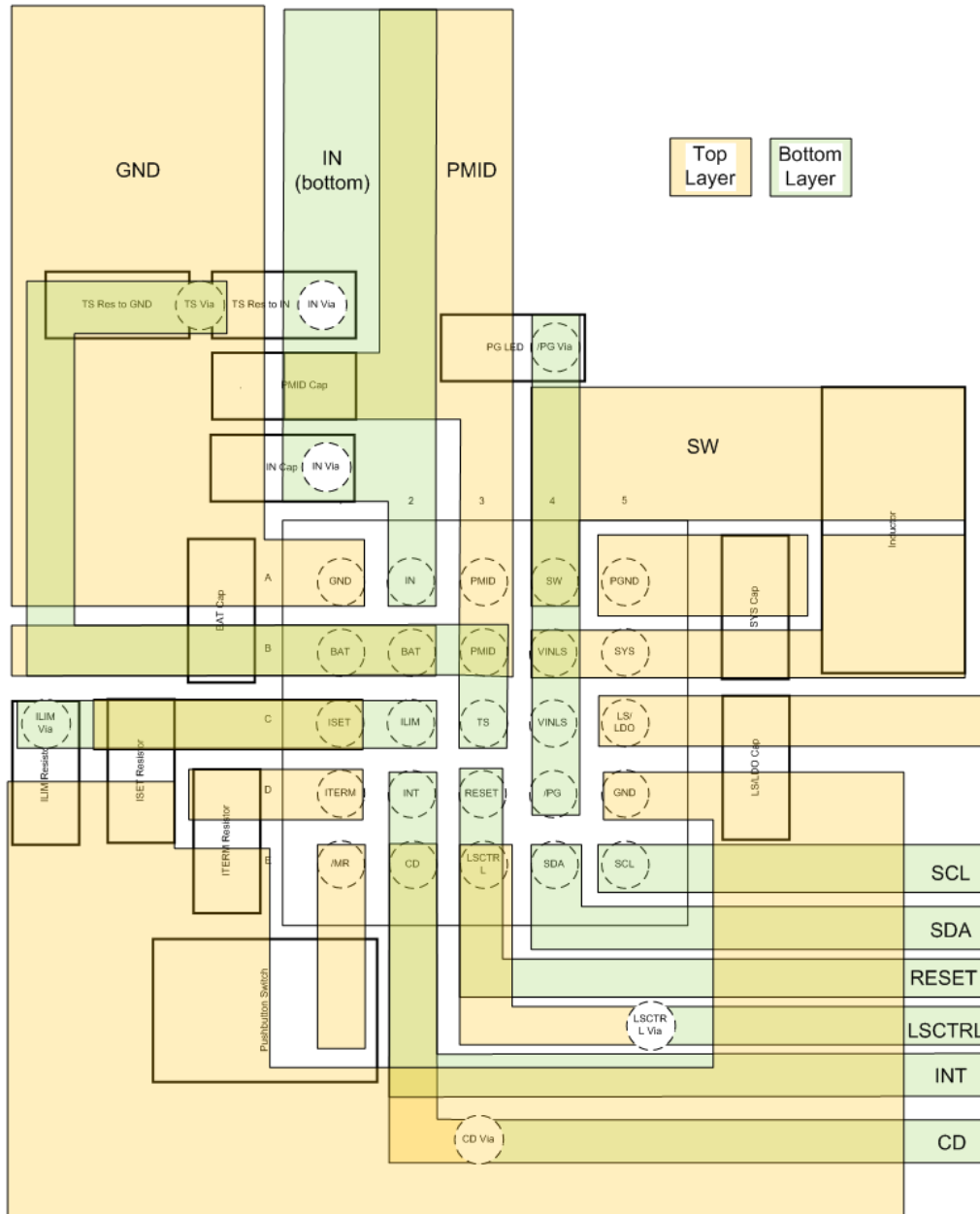

Figure 103. bq25120 Layout

13 Device and Documentation Support

13.1 Device Support

13.1.1 Third-Party Products Disclaimer

TI'S PUBLICATION OF INFORMATION REGARDING THIRD-PARTY PRODUCTS OR SERVICES DOES NOT CONSTITUTE AN ENDORSEMENT REGARDING THE SUITABILITY OF SUCH PRODUCTS OR SERVICES OR A WARRANTY, REPRESENTATION OR ENDORSEMENT OF SUCH PRODUCTS OR SERVICES, EITHER ALONE OR IN COMBINATION WITH ANY TI PRODUCT OR SERVICE.

13.2 Related Links

The table below lists quick access links. Categories include technical documents, support and community resources, tools and software, and quick access to sample or buy.

Table 24. Related Links

PARTS	PRODUCT FOLDER	SAMPLE & BUY	TECHNICAL DOCUMENTS	TOOLS & SOFTWARE	SUPPORT & COMMUNITY
BQ25120	Click here	Click here	Click here	Click here	Click here
BQ25121	Click here	Click here	Click here	Click here	Click here

13.3 Community Resources

The following links connect to TI community resources. Linked contents are provided "AS IS" by the respective contributors. They do not constitute TI specifications and do not necessarily reflect TI's views; see TI's [Terms of Use](#).

TI E2E™ Online Community *TI's Engineer-to-Engineer (E2E) Community*. Created to foster collaboration among engineers. At e2e.ti.com, you can ask questions, share knowledge, explore ideas and help solve problems with fellow engineers.

Design Support *TI's Design Support* Quickly find helpful E2E forums along with design support tools and contact information for technical support.

13.4 Trademarks

E2E is a trademark of Texas Instruments.
All other trademarks are the property of their respective owners.

13.5 Electrostatic Discharge Caution



These devices have limited built-in ESD protection. The leads should be shorted together or the device placed in conductive foam during storage or handling to prevent electrostatic damage to the MOS gates.

13.6 Glossary

SLYZ022 — *TI Glossary*.

This glossary lists and explains terms, acronyms, and definitions.

14 Mechanical, Packaging, and Orderable Information

The following pages include mechanical, packaging, and orderable information. This information is the most current data available for the designated devices. This data is subject to change without notice and revision of this document. For browser-based versions of this data sheet, refer to the left-hand navigation.

PACKAGING INFORMATION

Orderable Device	Status (1)	Package Type	Package Drawing	Pins	Package Qty	Eco Plan (2)	Lead/Ball Finish (6)	MSL Peak Temp (3)	Op Temp (°C)	Device Marking (4/5)	Samples
BQ25120YFPR	ACTIVE	DSBGA	YFP	25	3000	Green (RoHS & no Sb/Br)	SNAGCU	Level-1-260C-UNLIM	-40 to 85	BQ25120	Samples
BQ25120YFPT	ACTIVE	DSBGA	YFP	25	250	Green (RoHS & no Sb/Br)	SNAGCU	Level-1-260C-UNLIM	-40 to 85	BQ25120	Samples
BQ25121YFPR	ACTIVE	DSBGA	YFP	25	3000	Green (RoHS & no Sb/Br)	SNAGCU	Level-1-260C-UNLIM	-40 to 85	BQ25121	Samples
BQ25121YFPT	ACTIVE	DSBGA	YFP	25	250	Green (RoHS & no Sb/Br)	SNAGCU	Level-1-260C-UNLIM	-40 to 85	BQ25121	Samples

(1) The marketing status values are defined as follows:

ACTIVE: Product device recommended for new designs.

LIFEBUY: TI has announced that the device will be discontinued, and a lifetime-buy period is in effect.

NRND: Not recommended for new designs. Device is in production to support existing customers, but TI does not recommend using this part in a new design.

PREVIEW: Device has been announced but is not in production. Samples may or may not be available.

OBSOLETE: TI has discontinued the production of the device.

(2) Eco Plan - The planned eco-friendly classification: Pb-Free (RoHS), Pb-Free (RoHS Exempt), or Green (RoHS & no Sb/Br) - please check <http://www.ti.com/productcontent> for the latest availability information and additional product content details.

TBD: The Pb-Free/Green conversion plan has not been defined.

Pb-Free (RoHS): TI's terms "Lead-Free" or "Pb-Free" mean semiconductor products that are compatible with the current RoHS requirements for all 6 substances, including the requirement that lead not exceed 0.1% by weight in homogeneous materials. Where designed to be soldered at high temperatures, TI Pb-Free products are suitable for use in specified lead-free processes.

Pb-Free (RoHS Exempt): This component has a RoHS exemption for either 1) lead-based flip-chip solder bumps used between the die and package, or 2) lead-based die adhesive used between the die and leadframe. The component is otherwise considered Pb-Free (RoHS compatible) as defined above.

Green (RoHS & no Sb/Br): TI defines "Green" to mean Pb-Free (RoHS compatible), and free of Bromine (Br) and Antimony (Sb) based flame retardants (Br or Sb do not exceed 0.1% by weight in homogeneous material)

(3) MSL, Peak Temp. - The Moisture Sensitivity Level rating according to the JEDEC industry standard classifications, and peak solder temperature.

(4) There may be additional marking, which relates to the logo, the lot trace code information, or the environmental category on the device.

(5) Multiple Device Markings will be inside parentheses. Only one Device Marking contained in parentheses and separated by a "~" will appear on a device. If a line is indented then it is a continuation of the previous line and the two combined represent the entire Device Marking for that device.

(6) Lead/Ball Finish - Orderable Devices may have multiple material finish options. Finish options are separated by a vertical ruled line. Lead/Ball Finish values may wrap to two lines if the finish value exceeds the maximum column width.

Important Information and Disclaimer: The information provided on this page represents TI's knowledge and belief as of the date that it is provided. TI bases its knowledge and belief on information provided by third parties, and makes no representation or warranty as to the accuracy of such information. Efforts are underway to better integrate information from third parties. TI has taken and continues to take reasonable steps to provide representative and accurate information but may not have conducted destructive testing or chemical analysis on incoming materials and chemicals. TI and TI suppliers consider certain information to be proprietary, and thus CAS numbers and other limited information may not be available for release.

In no event shall TI's liability arising out of such information exceed the total purchase price of the TI part(s) at issue in this document sold by TI to Customer on an annual basis.

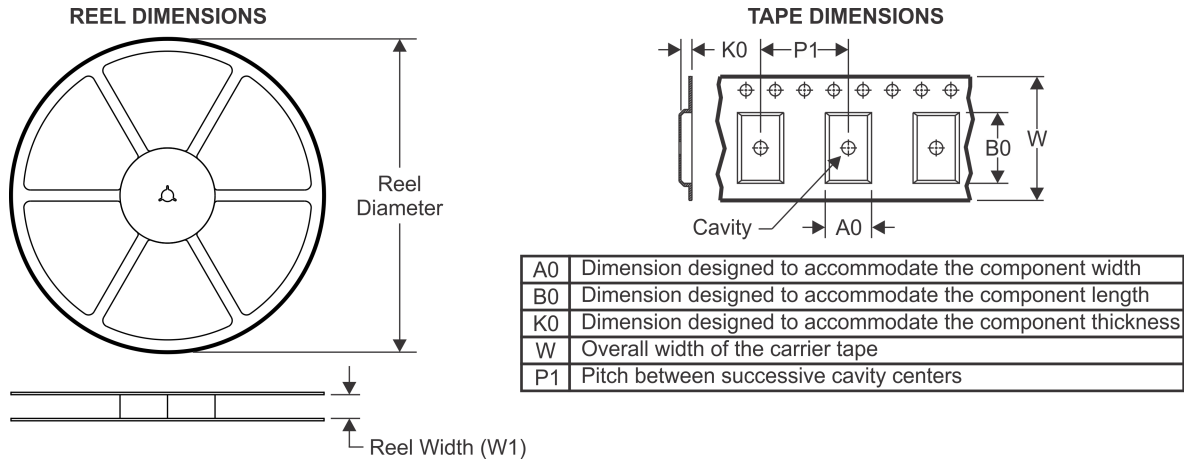
TAPE AND REEL INFORMATION

QUADRANT ASSIGNMENTS FOR PIN 1 ORIENTATION IN TAPE

*All dimensions are nominal

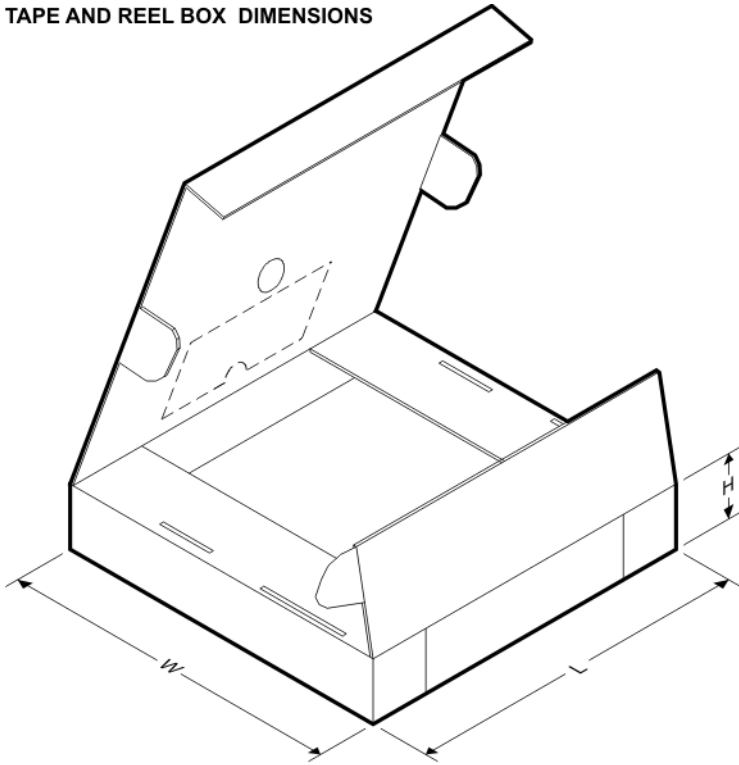
Device	Package Type	Package Drawing	Pins	SPQ	Reel Diameter (mm)	Reel Width W1 (mm)	A0 (mm)	B0 (mm)	K0 (mm)	P1 (mm)	W (mm)	Pin1 Quadrant
BQ25120YFPT	DSBGA	YFP	25	250	180.0	8.4	2.65	2.65	0.69	4.0	8.0	Q1
BQ25121YFPR	DSBGA	YFP	25	3000	180.0	8.4	2.65	2.65	0.69	4.0	8.0	Q1
BQ25121YFPT	DSBGA	YFP	25	250	180.0	8.4	2.65	2.65	0.69	4.0	8.0	Q1

TAPE AND REEL BOX DIMENSIONS

*All dimensions are nominal

Device	Package Type	Package Drawing	Pins	SPQ	Length (mm)	Width (mm)	Height (mm)
BQ25120YFPT	DSBGA	YFP	25	250	182.0	182.0	20.0
BQ25121YFPR	DSBGA	YFP	25	3000	182.0	182.0	20.0
BQ25121YFPT	DSBGA	YFP	25	250	182.0	182.0	20.0

MECHANICAL DATA

YFP (S-XBGA-N25)

DIE-SIZE BALL GRID ARRAY

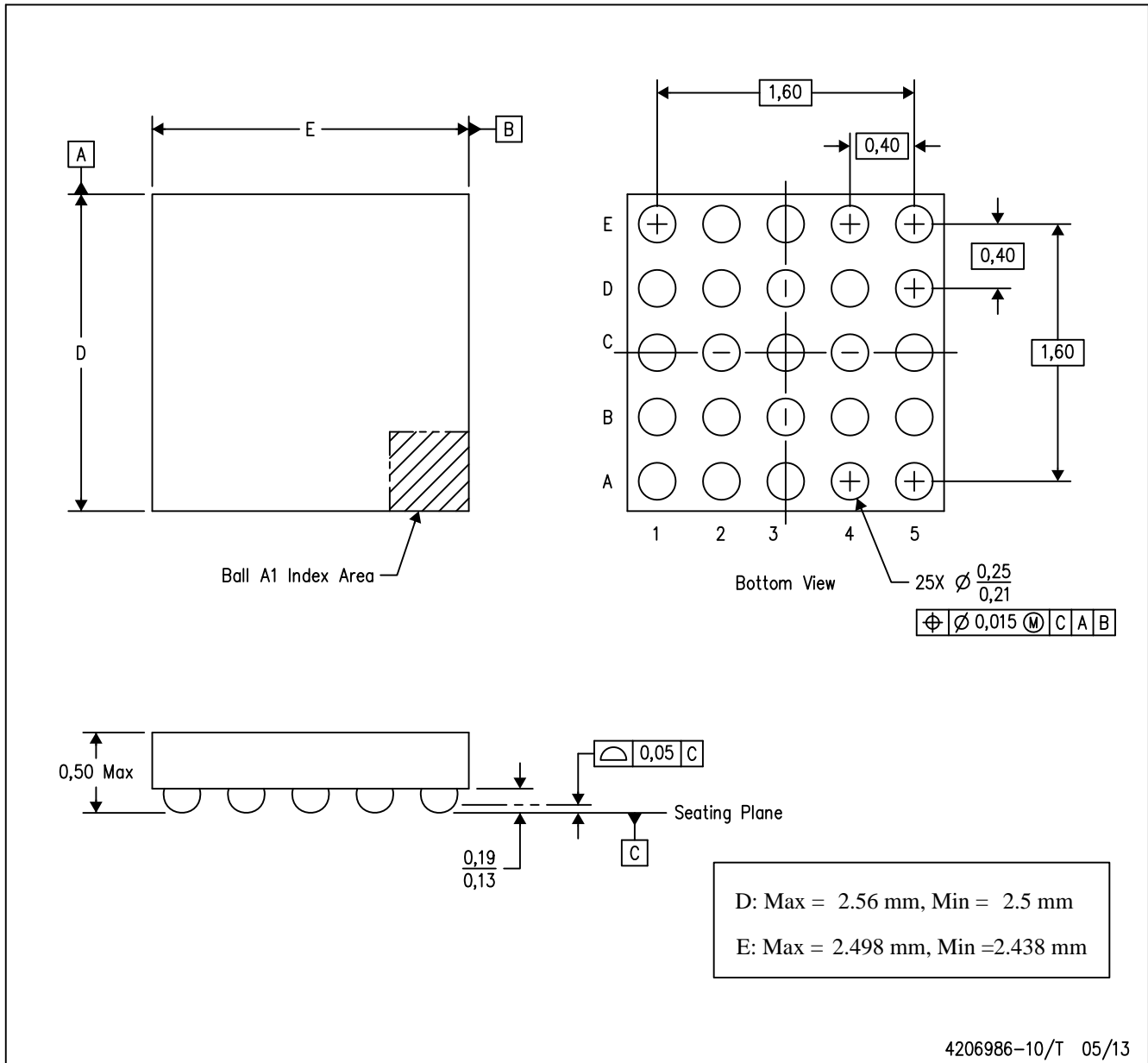

- NOTES:
- A. All linear dimensions are in millimeters. Dimensioning and tolerancing per ASME Y14.5M-1994.
 - B. This drawing is subject to change without notice.
 - C. NanoFree™ package configuration.

NanoFree is a trademark of Texas Instruments

IMPORTANT NOTICE

Texas Instruments Incorporated and its subsidiaries (TI) reserve the right to make corrections, enhancements, improvements and other changes to its semiconductor products and services per JESD46, latest issue, and to discontinue any product or service per JESD48, latest issue. Buyers should obtain the latest relevant information before placing orders and should verify that such information is current and complete. All semiconductor products (also referred to herein as "components") are sold subject to TI's terms and conditions of sale supplied at the time of order acknowledgment.

TI warrants performance of its components to the specifications applicable at the time of sale, in accordance with the warranty in TI's terms and conditions of sale of semiconductor products. Testing and other quality control techniques are used to the extent TI deems necessary to support this warranty. Except where mandated by applicable law, testing of all parameters of each component is not necessarily performed.

TI assumes no liability for applications assistance or the design of Buyers' products. Buyers are responsible for their products and applications using TI components. To minimize the risks associated with Buyers' products and applications, Buyers should provide adequate design and operating safeguards.

TI does not warrant or represent that any license, either express or implied, is granted under any patent right, copyright, mask work right, or other intellectual property right relating to any combination, machine, or process in which TI components or services are used. Information published by TI regarding third-party products or services does not constitute a license to use such products or services or a warranty or endorsement thereof. Use of such information may require a license from a third party under the patents or other intellectual property of the third party, or a license from TI under the patents or other intellectual property of TI.

Reproduction of significant portions of TI information in TI data books or data sheets is permissible only if reproduction is without alteration and is accompanied by all associated warranties, conditions, limitations, and notices. TI is not responsible or liable for such altered documentation. Information of third parties may be subject to additional restrictions.

Resale of TI components or services with statements different from or beyond the parameters stated by TI for that component or service voids all express and any implied warranties for the associated TI component or service and is an unfair and deceptive business practice. TI is not responsible or liable for any such statements.

Buyer acknowledges and agrees that it is solely responsible for compliance with all legal, regulatory and safety-related requirements concerning its products, and any use of TI components in its applications, notwithstanding any applications-related information or support that may be provided by TI. Buyer represents and agrees that it has all the necessary expertise to create and implement safeguards which anticipate dangerous consequences of failures, monitor failures and their consequences, lessen the likelihood of failures that might cause harm and take appropriate remedial actions. Buyer will fully indemnify TI and its representatives against any damages arising out of the use of any TI components in safety-critical applications.

In some cases, TI components may be promoted specifically to facilitate safety-related applications. With such components, TI's goal is to help enable customers to design and create their own end-product solutions that meet applicable functional safety standards and requirements. Nonetheless, such components are subject to these terms.

No TI components are authorized for use in FDA Class III (or similar life-critical medical equipment) unless authorized officers of the parties have executed a special agreement specifically governing such use.

Only those TI components which TI has specifically designated as military grade or "enhanced plastic" are designed and intended for use in military/aerospace applications or environments. Buyer acknowledges and agrees that any military or aerospace use of TI components which have **not** been so designated is solely at the Buyer's risk, and that Buyer is solely responsible for compliance with all legal and regulatory requirements in connection with such use.

TI has specifically designated certain components as meeting ISO/TS16949 requirements, mainly for automotive use. In any case of use of non-designated products, TI will not be responsible for any failure to meet ISO/TS16949.

Products

Audio	www.ti.com/audio
Amplifiers	amplifier.ti.com
Data Converters	dataconverter.ti.com
DLP® Products	www.dlp.com
DSP	dsp.ti.com
Clocks and Timers	www.ti.com/clocks
Interface	interface.ti.com
Logic	logic.ti.com
Power Mgmt	power.ti.com
Microcontrollers	microcontroller.ti.com
RFID	www.ti-rfid.com
OMAP Applications Processors	www.ti.com/omap
Wireless Connectivity	www.ti.com/wirelessconnectivity

Applications

Automotive and Transportation	www.ti.com/automotive
Communications and Telecom	www.ti.com/communications
Computers and Peripherals	www.ti.com/computers
Consumer Electronics	www.ti.com/consumer-apps
Energy and Lighting	www.ti.com/energy
Industrial	www.ti.com/industrial
Medical	www.ti.com/medical
Security	www.ti.com/security
Space, Avionics and Defense	www.ti.com/space-avionics-defense
Video and Imaging	www.ti.com/video

TI E2E Community

e2e.ti.com